

PRODUCT CATALOGUE

AUGUST 2017



**AUSTRALIAN
ENGINEERED
FOR A TOUGH
WORLD**



**AUSTRALIAN
ENGINEERED
FOR A TOUGH
WORLD**



**WORLDPOLY IS ONE OF
THE MOST SIGNIFICANT
MANUFACTURERS OF PE PIPE
WELDING EQUIPMENT IN THE
WORLD, SUPPLYING TO OVER
105 COUNTRIES**



WORLDPOLY. THREE GENERATIONS OF KNOWLEDGE AND EXPERIENCE



WORLDPOLY IS AN AUSTRALIAN OWNED AND BASED COMPANY THAT HAS SUCCESSFULLY LED THE POLYETHYLENE PIPE AND FITTINGS INDUSTRY FOR THREE GENERATIONS AND OVER 50 YEARS.

Leaders in the development and production of International Standard PE pipe welding fusion equipment, we now export to more than 105 countries.

From the mines in the deserts of South America and fish farms in Malaysia, to freeze-resistant welds in Antarctica and the technical requirements of Germany and Norway, we're proud to say we've done it all. We've got the expertise, experience and contacts to partner with you and tackle any project – big or small.

Not only do we manufacture and supply some of the best and most economical pipe welding machinery on the market, we also offer international training, advice and parts delivery – so you know

you've got on-ground support to ensure a premium outcome, every time.



INNOVATION THROUGH AUSTRALIAN ENGINEERING

**AUSTRALIAN
 ENGINEERED
 FOR A TOUGH
 WORLD**



“Our focus is appropriate innovation, driven by our constant pursuit for welding advancement and excellence as required in an increasingly competitive marketplace.”

Rob Hall, Chairman & CEO.

WORLDPOLY IS PROUD TO FEATURE AUSTRALIAN ENGINEERING EXPERIENCE IN OUR PE PIPE WELDING RANGE. WE HAVE PROUDLY INTRODUCED POLYFORCE TECHNOLOGY – A SERIES OF HIGH & LOW PRESSURE, ALL TERRAIN, TRACKED AND TRENCH MACHINES.

With the PolyForce630 Series 2, PolyForce 450 and PolyForce 315, any operator will enjoy the significantly reduced welding times, ease of use and data logging capability; backed by minimum

2 year warranties and significant Worldpoly application support and training.

FEATURES of the Australian Made PolyForce 630 Series II:

- High & low pressure welding
- CNC or manual operation
- Tracked, AllTerrain & Trench options
- Automatic and data logging
- Bosch Rexroth hydraulics
- Hydraulic clamps with crash protection
- Hydraulic operation of heating plate and facing tool
- Easy trench welding

- Safety
- Economy – low fuel consumption
- Flexibility – welding between clamps 2 & 3 or 3 & 4
- Pipe lifting rollers.

All Australian engineered machines carry the Worldpoly look in the Aussie Gold colour scheme, and if applicable; the Australian Government approved “Made In Australia” logo. Be assured, our Australian Engineered series is much more than a cosmetic overhaul. Each machine boasts impressive operator-friendly features, has significant additional options available, and includes extended warranties.

WORLDPOLY – PRODUCTS AND SERVICES IN DEMAND AROUND THE WORLD

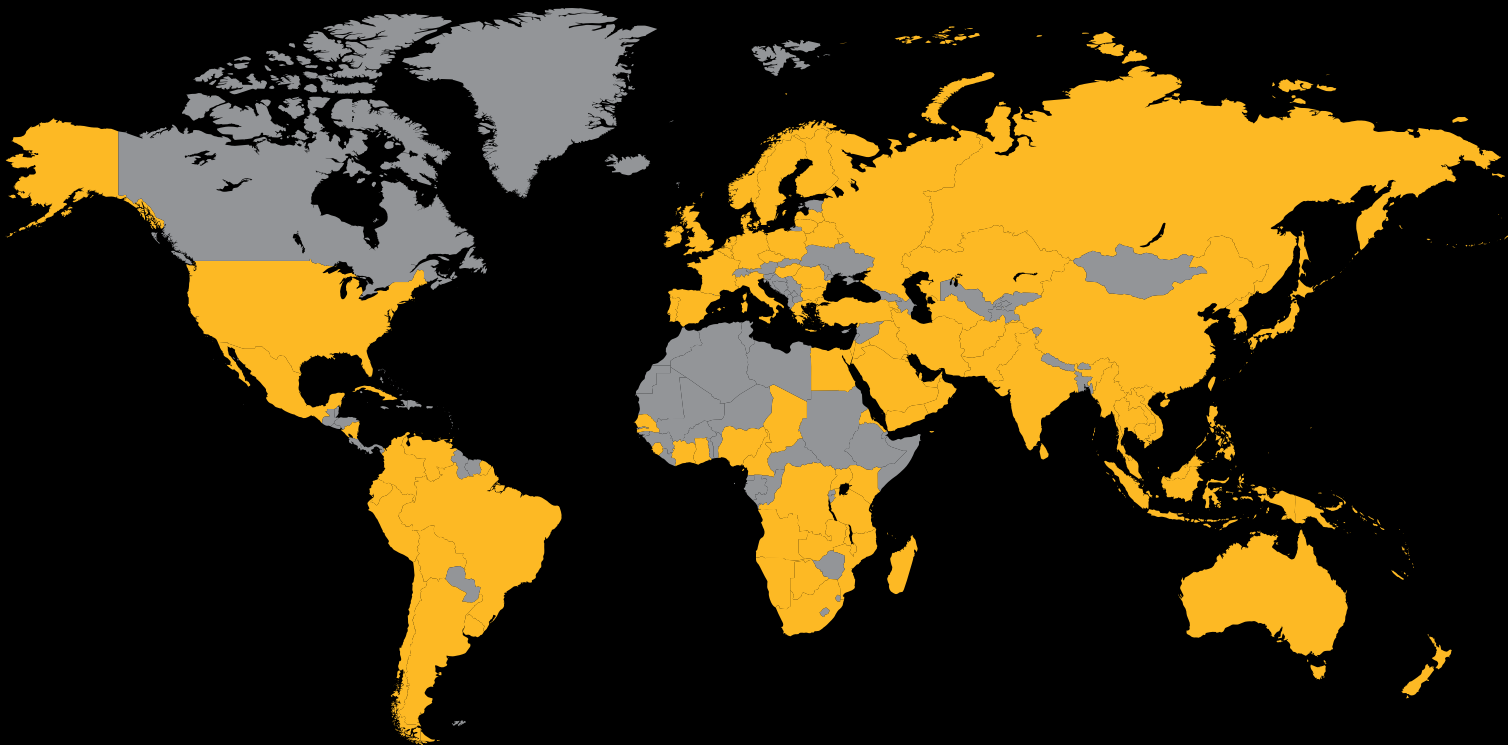

■ Indicates countries and regions with Worldpoly customers



“For over 50 years, Australia-based Worldpoly has been involved in the polyethylene pipe industry as a pipe extruder, fabricator, consultant and now major manufacturer of pipe welding equipment.”

Nikita Hall
Worldpoly Sales Manager



AUSTRALIAN ENGINEERED FOR A TOUGH WORLD

INCREASING POTENTIAL THROUGH ONGOING SUPPORT

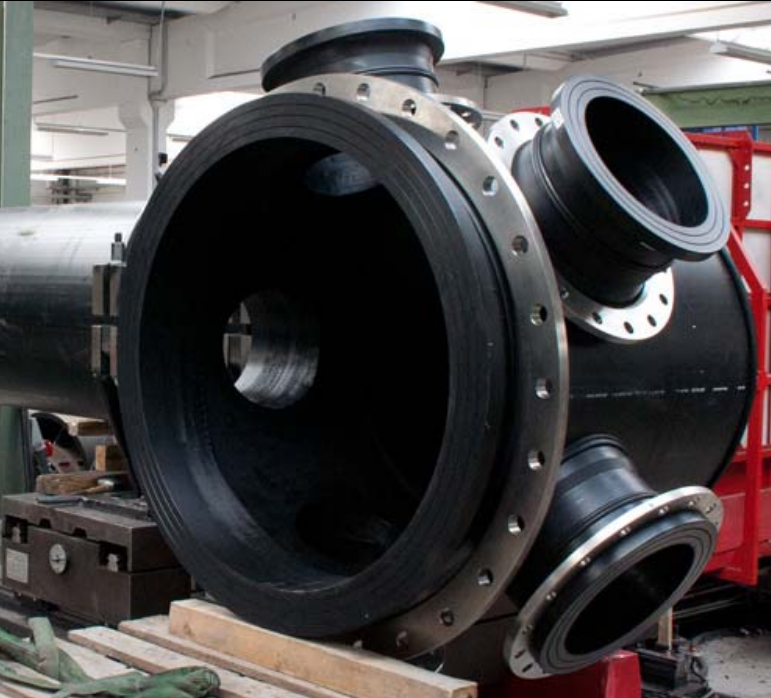

WHAT SETS WORLDPOLY ASIDE FROM OUR COMPETITORS

Our guarantee to provide customers with access to trained technicians in all aspects of field and factory service. Our Service Engineers hold up-to-date qualifications, accredited licensing and years of practical hands-on expertise.

Servicing Worldpoly machines is only half the story – we also provide spare parts for even our oldest and earliest machines. Worldpoly machines are built to

meet the ongoing productivity demands expected by our customers.

Whether it is routine maintenance, or special servicing programs for customers with particular needs, Worldpoly is there to keep you working.

INCREASING POTENTIAL THROUGH ONGOING SUPPORT.

At Worldpoly, we understand how critical ongoing support is to the success of every project, no matter what the size.

We invest in highly qualified and experienced Application Technicians to train and assist our customers in safely and productively operating Worldpoly equipment to get optimal performance – no matter if your machine is old, new, in the field or in the workshop.

Beyond our standard guarantee of access to an Applications Technician, our Applications Group also provides support to customers who seek to further develop their activities.

THE EXPANSE OF WORLDPOLY



REGIONS SERVICED BY OUR DEALER NETWORK

For dealer contact details see back cover

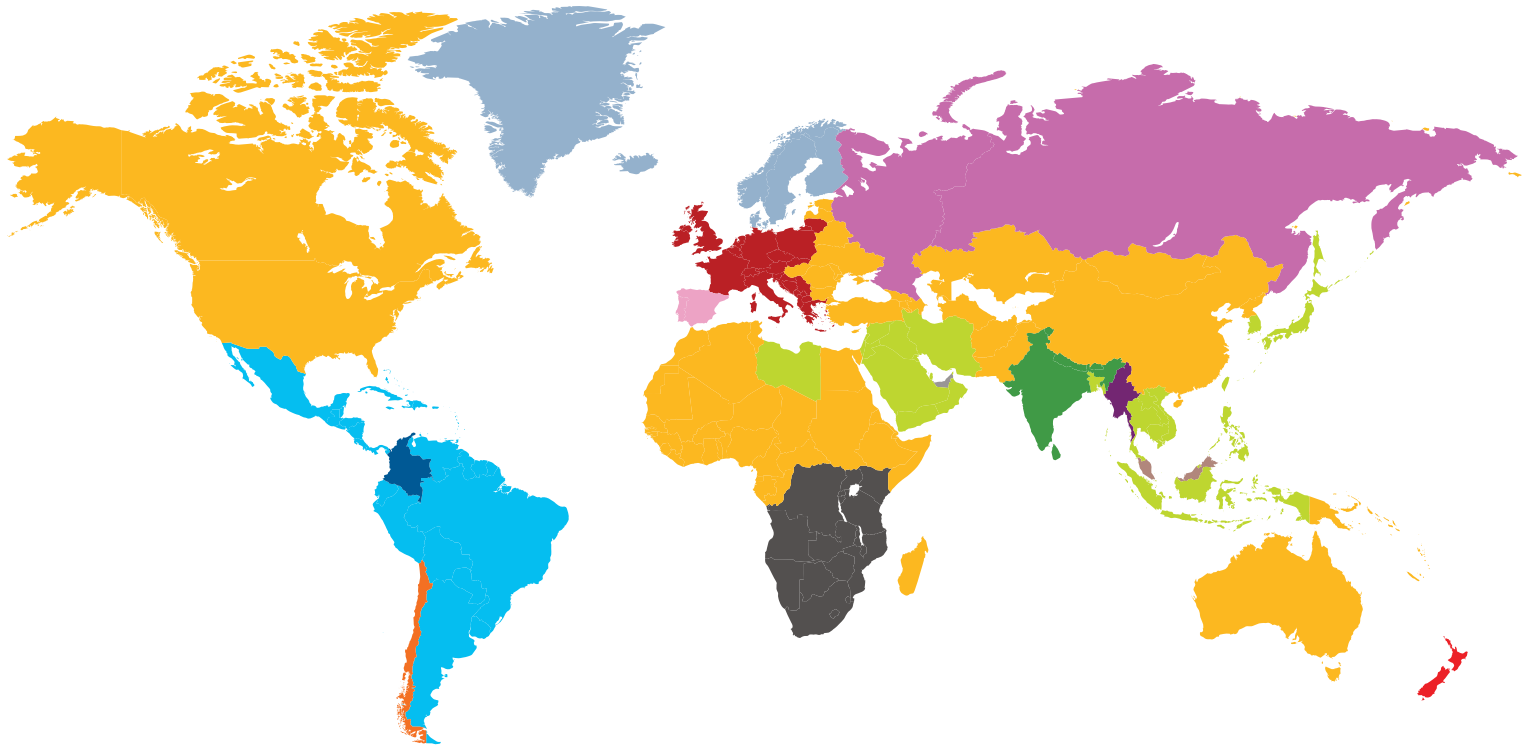

- | | | |
|--|---|--|
|  Australia |  India |  Philippines |
|  Asia and Middle East |  Latin America |  Scandinavia |
|  Chile |  Mexico |  Spain and Portugal |
|  Colombia |  New Zealand |  Sub-Saharan Africa |
|  Germany |  Panama |  United Arab Emirates |

WORLDPOLY SUPPLIES TO, SUPPORTS AND SERVICES OUR MACHINES IN ALL CONTINENTS AND TO THE FOUR CORNERS OF THE GLOBE. IN MANY REGIONS WE DO THIS WITH A TEAM OF DISTRIBUTORS WHO WE ARE ENORMOUSLY PROUD TO BE ASSOCIATED WITH.

Each of our distributors are well established and have earned an esteemed and respected reputation in their own right. Many of these distributors have been associated with the Hall family for more than 30 years.

We have mutually agreed Customer Satisfaction processes and benchmarks so that any Worldpoly machine delivered anywhere in the world will be serviced and supported at the same high standard.

Our distribution and freight criteria levels ensure swift response times for Service and Support enquiries and deliveries – particularly spare parts.

In regions not serviced by Worldpoly Distributors, we work directly with clients for the fastest and most cost effective solution.

Having employees speaking twelve languages, as well as 50 years of experience and servicing more than 105 countries, Worldpoly will be able to offer an appropriate solution for your needs.

TRAINING THE SECRET TO SUCCESS



Malaysia



Phillippines



Ghana



New Caledonia

THE TECHNIQUE IS IN THE TRAINING

AT WORLDPOLY, WE BELIEVE THAT TRAINING THE USERS OF OUR MACHINERY IS JUST AS IMPORTANT AS SUPPLYING THE MACHINES THEMSELVES – IT ENSURES EASE OF USE, QUALITY WORKMANSHIP AND DURABILITY OF ANY PIPELINE OR FITTING.

OUR TRAINING COMMITMENT

Worldpoly is committed to provide you with the tools and know-how to build a reputation of excellence, consistency, reliability and profitability. We do this by assessing the level of training your team requires and then tailoring a program to ensure you're getting the best out of your machines.

Worldpoly operates resident training schools in a number of countries. Please check with your distributor or Worldpoly direct for the closest location.

“

It is a pleasure to train our customers to not only be proficient in the use of their latest equipment but to also help them expand their commercial possibilities in engineering and manufacture.

”

*Rameïss Paker
Worldpoly General Manager
Asia and Middle East*

QUALITY ASSURANCE AND ADVICE



WITH CLIENTS IN OVER 105 COUNTRIES, AND MORE THAN 50 YEARS OF ACTIVE HISTORY IN THE PE INDUSTRY, WORLDPOLY HAS A LONG TRACK RECORD OF SUCCESS DUE TO OUR COMMITMENT TO UNDERSTAND OUR CLIENT'S NEEDS AND PROVIDE OUTCOME-FOCUSED SOLUTIONS.



BE ASSURED

All Worldpoly Machines carrying the CE mark are specifically developed and manufactured with CE Approval in mind. This ensures that these Worldpoly machines exceed the requirements of all international markets that demand the highest standard of safety.

Worldpoly Machines carrying the CE mark and have Internationally recognised SGS approval. You can be assured that our machines are designed and manufactured to enable you to operate in a more sustainable manner - improving quality and productivity and reducing risk to health and safety.

MANUFACTURING ACCOLADE

Worldpoly holds accreditation to ISO 9001.



OUR EXPERIENCE IS YOUR SOLUTION

Getting the right advice can save you time and money.

At Worldpoly our specialist team has decades of experience in every application of PE pipe and the best methods to weld it for durability, consistency and reliability. They also have the skills and expertise to help you find the solution to your problem, no matter how impossible it may seem.

Our team members' combined experiences have given us a pool of knowledge, which you can draw from to ensure the success of your operation.

CONTENTS **WORLDPOLY** PRODUCT CATALOGUE **AUGUST 2017**



FIELD WELDING MACHINES

POLYFORCE AND POLYROVER

PolyRover630/24 Trench	315-630mm OD, low force	13
PolyRover630/24 AllTerrain	315-630mm OD, low force	15
PolyRover1000/24 AllTerrain	500 to 1000mm, low pressure	17
PolyForce630/24 CNC Trench	315 to 630mm Dual Pressure	19
PolyForce630/24 CNC AllTerrain	315 to 630mm Dual Pressure	21
PolyForce630/24 CNC Track	315 to 630mm Dual Pressure	23
PolyForce1000/40 CNC Trench	500-1000mm/20"-40" OD, Dual Pressure	25
PolyForce1000/40 CNC AllTerrain	500-1000mm/18"-40" OD, Dual Pressure	26
PolyForce1000/40 CNC Tracked	500-1000mm/18"-40" OD, Dual Pressure	28
PolyTrack	PolyForce630 & 1000 Machines	30

FIELD WELDING MACHINES – METRIC

PolyBasic160	40-160mm OD manual	31
Worldpoly160	50-160mm OD hydraulic	32
Worldpoly250	50-250mm OD hydraulic	33
Worldpoly315	90-315mm OD hydraulic	34
Worldpoly315 High Pressure	90-315mm OD hydraulic	35
Worldpoly315 CNC	110-315mm OD hydraulic	36
Worldpoly450	200-450mm OD hydraulic	37
Worldpoly450 High Pressure	200-450mm OD hydraulic	38
Worldpoly500	200-500mm OD hydraulic	40
Worldpoly630	315-630mm OD hydraulic	42
Worldpoly800	450-800mm OD hydraulic	44
Worldpoly1000	500-1000mm OD hydraulic	46
Worldpoly1000/40 Hydra	500-1000mm OD hydraulic	48
Worldpoly1200	630-1200mm OD hydraulic	49
Worldpoly1200/48 Hydra	630-1200mm OD hydraulic	51
Worldpoly1600	1000-1600mm OD hydraulic	53
Worldpoly1600 Hydra	100-1600mm OD hydraulic	54
Worldpoly2000	1400-2000mm OD hydraulic	55
Worldpoly2400	1400-2400mm OD hydraulic	56
Trolleys		57

FIELD WELDING MACHINES – IMPERIAL

PolyBasic6"	2" - 6" IPS	58
Worldpoly 8" High Pressure	High Pressure 8" to 16"	59
Worldpoly 10" High Pressure	High Pressure 3" to 10"	60
Worldpoly 16" High Pressure	High Pressure 8" to 16"	61
Rentals		62

FABRICATION MACHINES

WORKSHOP WELDING MACHINES

PolyWorkshop315/90	90-315mm OD bends, tees, crosses, branches	64
PolyWorkshop450/160	160-450mm OD bends, tees, crosses, branches	64
PolyWorkshop450Y	160-450mm OD bends, tees, crosses, branches	65
PolyWorkshop630/315 CNC	315-630mm OD bends, tees, crosses, branches	65
PolyWorkshop24/12 CNC	12"-24" OD bends, tees, crosses, branches	66
PolyWorkshop800/450	450-800mm OD bends, tees, crosses, branches	66
PolyWorkshop800/355 CNC	355-800mm OD bends, tees, crosses, branches	67
PolyWorkshop1000/500 CNC	500-1000mm OD bends, tees, crosses, branches	67
PolyWorkshop1200/630	630-1200mm OD bends, tees, crosses, branches	68
PolyWorkshop1600/1000	1000-1600mm OD bends, tees, crosses, branches	68
PolyWorkshop 2000/1400	1400-2000mm OD Y clamp ready	69

WORKSHOP PIPE SAWS

PolySaw315/12	90-315mm OD cuts to 67 degrees	70
PolySaw630/24	90-630mm OD cuts to 67 degrees	70
PolySaw800/32	90-800mm OD cuts to 67 degrees	71
PolySaw1200/48	630-1200mm OD cuts to 67 degrees	71
PolySaw1600/65	630-1600mm OD cuts to 67 degrees	72
PolySaw1710/68"	630mm / 24"-1720mm / 68" OD cuts to 67 degrees	72
PolySaw2000/78"	1200mm - 2000mm OD	73
PolySaddleSaw500	63mm - 500mm OD	73

SADDLE FUSION MACHINES

PolySaddle630/315	315 to 630mm main pipe / 63 to 315mm outlet	75
PolySaddle1200/500 (48"/12")	315 to 1200mm main pipe / 63 to 500mm outlet	76

ELECTROFUSION

WELDERS

ATS180	Welds electrofusion fittings 16 to 180mm OD	78
ATS250	Welds electrofusion fittings 16 to 400mm OD	80
LP215	Welds electrofusion fittings 32 to 315mm OD	81
ACT3	Welds electrofusion fittings 16 to 630mm OD	82
ATS High Power	Welds electrofusion fittings 16 to 1200mm OD	83
ATS 4000	Welds electrofusion fittings 500 to 4000mm OD	85

ACCESSORIES

PowerScrape 1200	Scrapes Pipe 355 - 1200mm	87
PolyScraper40	Blade width 40mm/1.5"	88
PolyScraper62	Blade width 62mm/2.5"	88
Vee Clamp 250	Clamps Pipe 55 - 250mm OD	89
Vee Clamp 500	Clamps Pipe 55 - 500mm OD	89
Multi Clamp180	Clamps Pipe 55 - 180mm OD	90
Multi Clamp180T	Clamps Pipe 55 - 180mm OD	90
VariClampUniversal	Clamps Pipe 55 - 180mm OD	91
SaddleClamp500	Clamps Pipe upto 500mm	91

GENERAL MACHINES & ACCESSORIES

EXTRUSION WELDING

Weldplast S2		93
Fusion 2		93
Fusion 3		94
Fusion 3C		94
ASTRO		95
COMET		95

DATA LOGGING

SPG 2.0		96
DataMaster		96

ACCESSORIES

PolyRoller1000	Adjustable pipe roller stand 50-1000mm	97
PolySling 500	Suitable from 100 to 500mm OD PE pipe	97
PolySling1000	Suitable from 315 to 1000mm OD PE pipe	97
PolySling1200	Suitable from 50 to 1200mm OD PE pipe	97
SqueezeOff32	Compresses Pipe 16 - 32 mm	98
SqueezeOff63	Squeezes Pipe 20 - 63 mm	98
SqueezeOff90	Squeezes Pipe 55 - 90 mm	98
SqueezeOff125	Squeezes Pipe 63 - 125 mm	98
ButtWipe	Equipment Cleaner	98
PipeSecateur75	Operating range 16-75mm	99
External Bebeader125	Debead upto 125mm	99
External Bebeader400	Debead upto 400mm	99
External Bebeader500	Debead upto 500mm	99
External Bebeader900	Debead upto 900mm	99
Internal Debeader90-450	Debeads Pipe 90 - 45mm	100
Internal Debeader500-630	Debeads Pipe 500 - 630mm	100

FIELD WELDING MACHINES



Equipment for welding and fusion of pipes and fittings in the field. Includes pipeline welding equipment for low and high-force fusion, hydraulic and manual machines. The Worldpoly range of machines can suit any application or budget.

- **FIELD WELDING MACHINES - METRIC**
- **FIELD WELDING MACHINES - IMPERIAL**
- **FIELD WELDING MACHINES - RENTAL**



PolyRover630/24 Trench

Australian Made PolyRover630/24 Trench reduces workload and the need for extra support equipment on remote sites, allowing faster, more efficient welding of PE and PP pipelines.

Fast changeover time improves weld quality and consistency.

Practical design using Bosch Rexroth hydraulics, PolyRover features hydraulically lifted facing tool and heating plate, hydraulic pump and controls all on-board the main frame, easy trench use, welding between clamps 2 and 3 or 3 and 4 for tight fittings work, plus high quality and sturdy construction, provides an excellent machine for pipeline welding. Born from more than 55 years and three generations of experience with PE pipe and three dedicated years of research and development with Bosch Rexroth, and having clients in more than 105 countries, Worldpoly manufactures the PolyRover range in Australia to provide a single platform for welding, according to low and optionally high pressure standards. Worldpoly PolyRover machines are specifically designed for use in rugged and remote terrain, are easily operated and are pre-wired for the attachment of Worldpoly or other data loggers.

TECHNICAL SPECIFICATIONS

Australian made

Genuine 5 year international warranty

Main frame includes:

- 4 clamp sets for 630mm diameter
- Welding range 315mm to 630mm, SDR 9 (PN16) to SDR 41 (PN4), according to DVS, ISO and AUS/NZ POP003 low force
- High pressure welding option available according to USA, ISO and AUS/NZ POP003 high pressure Standards, welding range 315 to 630mm or 12" to 24"
- Easily able to weld between clamps 3 and 4 for tight fittings and fabrications
- Entire welding frame with 4 clamps and all hydraulics is easily removed for trench work, allowing accurate alignment
- Fork lift and overhead lifting points

Includes reducing liners to weld pipe within the complete specified range:

- Metric – 630, 560, 500, 450, 400, 355 and 315mm OD

Alternatively:

- Inch – 24, 22, 20, 18, 16, 14 and 12"

Hydraulically lifted cast Aluminium PTFE coated heating plate with electronic temperature control and insulated cover

Hydraulically lifted and electrically operated cast Aluminium electric facing tool, thermostatically controlled with current overload protection

High quality and remotely serviceable Bosch Rexroth electro-hydraulic pump and hydraulics.

Wired ready to accept Worldpoly and other data loggers

Operating voltage:

- Standard 400 volt 3 phase 50 Hz 16.8kW. Requires generator minimum 18 KVA.

Modular controls located in convenient operator position include:



- All hydraulic operation controls
- Digital pressure readout
- Countdown timer
- Emergency stop
- IP63

Tool box including spare blades, thermocouple, temperature controller, tools etc

Options include:

- Welding according to low pressure, or alternatively both low and high pressure welding standards (must be specified at time of quotation / order confirmation)
- Stub end device for welding end fittings (available in Aluminium or Steel)

Clamp options include:

- Layer clamps metric: 630 x 560, 560 x 500, 500 x 450, 450 x 400, 400 x 355 and 355 x 315mm
- Layer clamps inch: 24" x 22", 22" x 20", 20" x 18", 18" x 16", 16" x 14" and 14" x 12"
- Narrow clamps metric: 630 x 560, 630 x 500, 630 x 450, 630 x 400, 630 x 355, 630 x 315mm, as required for welding injection moulded or short-spigot fittings
- Two-piece clamps: 630 x 560, 630 x 500, 630 x 450, 450 x 400, 450 x 355, 450 x 315.

Please note technical specifications of Worldpoly machines may change without notice



PolyRover630/24 AllTerrain

Worldpoly PolyRover630/24 AllTerrain. Reducing workload and the need for extra support equipment on remote sites allows for faster, more efficient welding of PE and PP pipelines.

Fast changeover time improves weld quality and consistency.

Practical Australian design with hydraulically lifted facing tool and heating plate, optional hydraulic open/close/locking of pipe clamps, hydraulic pipe lifters left and right, hydraulic pump and controls all on-board the main frame, plus high quality and sturdy construction provides an excellent machine for pipeline welding. Born from more than 55 years and three generations of experience with PE pipe plus 3 years of dedicated research and development with Bosch Rexroth, and having clients in more than 105 countries, Worldpoly manufactures the PolyRover range in Australia to provide a single platform for welding, according to low-force or optionally high-force standards. Worldpoly PolyRover machines are specifically designed for use in rugged and remote terrain, easily operated and are pre-wired for the attachment of Worldpoly or other data loggers. Hydraulics are highest quality and internationally serviceable Bosch Rexroth. Electrics are all local. Absolutely Australian Made. Unbeatable.

TECHNICAL SPECIFICATIONS

Australian made

Genuine 5 year International warranty

Main frame includes 4 clamp sets for 630mm diameter:

- Welding range 315mm to 630mm, SDR 9 (PN16) to SDR 41 (PN4), according to DVS, ISO and AUS/NZ POP003 low force
- High force welding option available according to USA, ISO and AUS/NZ POP003 high pressure Standards.
- Easily able to weld between clamps 3 and 4 for tight fittings and fabrications
- Entire welding frame with 4 clamps easily removed for trench work, allowing accurate alignment
- Fork lift and overhead lifting points

Includes reducing liners to weld pipe within the complete specified range:

- Metric – 630, 560, 500, 450, 400, 355 and 315mm OD

Alternatively:

- Inch – 24, 22, 20, 18, 16, 14 and 12"

Hydraulically lifted cast Aluminium PTFE coated heating plate with electronic temperature control and insulated cover

Hydraulically lifted and electrically operated cast Aluminium electric facing tool, thermostatically controlled with current overload protection

High quality and remotely serviceable Bosch Rexroth electro-hydraulic pump, valves and controls

Wired ready to accept Worldpoly and other data loggers

Operating voltage:

- Standard 400 volt 3 phase 50 Hz 14.6kW, 23A. Requires generator minimum 18 KVA.



Modular controls located in convenient operator position include:

- All welding operation controls
- Digital pressure readout
- Countdown timer
- Emergency stop

Steerable wheeled base readily removable for trench work

- High quality wide profile all-terrain wheels and tyres
- Hydraulic pipe lifters front and rear
- Offset steering
- Not road registrable

Tool box including spare blades, thermocouple, temperature controller, tools etc

Options include:

- Welding according to low pressure, or alternatively both low and high pressure welding standards
- Stub end device for welding end fittings (available in Aluminium or Steel)

Clamp options include:

- Supplied with the machine - Layer clamps metric: 630 x 560, 560 x 500, 500 x 450, 450 x 400, 400 x 355 and 355 x 315mm
- Optional layer clamps inch: 24" x 22", 22" x 20", 20" x 18", 18" x 16", 16" x 14" and 14" x 12"
- Two-piece clamps 630 x 560, 630 x 500, 630 x 450, 450 x 400, 450 x 355, 450 x 315mm
- Narrow clamps metric: 630 x 560, 630 x 500, 630 x 450, 630 x 400, 630 x 355, 630 x 315mm, as required for welding injection moulded or short-spigot fittings

Please note technical specifications of Worldpoly machines may change without notice



PolyRover1000 AllTerrain

Worldpoly PolyRover1000 AllTerrain. Reducing workload and the need for extra support equipment on remote sites allows for faster, more efficient welding of PE and PP pipelines.

Fast changeover time improves weld quality and consistency.

Practical Australian design with hydraulically lifted facing tool and heating plate, optional hydraulic open/close/locking of pipe clamps, hydraulic pipe lifters left and right, hydraulic pump and controls all on-board the main frame, plus high quality and sturdy construction provides an excellent machine for pipeline welding. Born from more than 55 years and three generations of experience with PE pipe plus 3 years of dedicated research and development with Bosch Rexroth, and having clients in more than 105 countries, Worldpoly manufactures the PolyRover range in Australia to provide a single platform for welding, according to low force standards. Worldpoly PolyRover machines are specifically designed for use in rugged and remote terrain, easily operated and are pre-wired for the attachment of Worldpoly or other data loggers. Hydraulics are highest quality and internationally serviceable Bosch Rexroth. Electrics are all local. Absolutely Australian Made. Unbeatable.

TECHNICAL SPECIFICATIONS

Australian made

Genuine 5 year International warranty

Main frame includes 4 clamp sets for 1000mm diameter:

- Welding range 500mm to 1000mm, SDR 9 (PN16) to SDR 41 (PN4), according to DVS, ISO and AUS/NZ POP003 low force
- High force welding option available according to USA, ISO and AUS/NZ POP003 high pressure Standards.
- Easily able to weld between clamps 3 and 4 for tight fittings and fabrications
- Entire welding frame with 4 clamps easily removed for trench work, allowing accurate alignment
- Fork lift and overhead lifting points

Includes reducing liners to weld pipe within the complete specified range:

- Metric – 1000, 900, 800, 710, 630, 560 & 500mm OD

Hydraulically lifted cast Aluminium PTFE coated heating plate with electronic temperature control and insulated cover

Hydraulically lifted and electrically operated cast Aluminium electric facing tool, thermostatically controlled with current overload protection

High quality and remotely serviceable Bosch Rexroth electro-hydraulic pump, valves and controls

Wired ready to accept Worldpoly and other data loggers

Operating voltage:

- Standard 400 volt 3 phase 50 Hz 30.8 kw, 50.2 A.

Modular controls located in convenient operator position include:

- All welding operation controls
- Digital pressure readout



- Countdown timer

- Emergency stop

Steerable wheeled base readily removable for trench work

- High quality wide profile all-terrain wheels and tyres

- Hydraulic pipe lifters front and rear

- Offset steering

- Not road registrable

Tool box including spare blades, thermocouple, temperature controller, tools etc

Options include:

- Welding according to low pressure, or alternatively both low and high pressure welding standards

- Stub end device for welding end fittings (available in aluminium or steel)

Clamp options include:

- Supplied with the machine - Layer clamps metric: 1000x900, 900x800, 800x710, 710x630, 630x560 & 560x500mm

- Two-piece clamps 1000x900, 1000x800, 1000x710, 1000x630, 630x560 & 630x500mm

- Narrow clamps metric: 1000x900, 900x800, 800x710, 710x630, 630x560 & 560x500mm, as required for welding injection moulded or short-spigot fittings

Please note technical specifications of Worldpoly machines may change without notice

PolyForce630/24 CNC Trench

Worldpoly PolyForce630/24 CNC AllTerrain Fusion Machine. Australian Made.

Born from more than 50 years and three generations of experience with PE pipe and a 3 year dedicated research and development project with Bosch Rexroth, Worldpoly manufactures the PolyRover and PolyForce range in Australia to provide today's HDPE pipe fusion machine for welding according to both high and low pressure standards.

PolyForce630 CNC provides the highest quality and most consistent high and low pressure butt fusion possible. High pressure (SHP) SDR 11 HDPE butt welds consistently test between 101% and 107% of host pipe strength.

Under the correct site conditions, PolyForce630/24 CNC can reduce welding time by more than 50%.

Occupational Health and Safety friendly operation.

Two-handed controls with dead-man switches, keyed hydraulic safety lockout, 4 x Cat3 E-stops, restricted human entry to danger zones. Operator training provided with every machine, including registered licence.

Machine can be set to operate only when this licence number is entered.

3.5 second automatic changeover time for 630mm / 24" OD SDR 11, and impossible to crash pipe faces after heating - reduces or eliminates brittle failure through operator variables.

Automatic intuitive CNC or manual control. Highest possible level of HDPE pipe weld quality, and easier to use than a smartphone.

Automatic control of temperature, time and pressure through the use of Bosch Rexroth's almost indestructible mobile PLC – the same as is used in underground rock drills.

Fully automatic heating, changeover and cooling cycle following entry of welding standard, pipe diameter and wall thickness or SDR.

Automatic detection of pipe slippage.

Incorporated 5,000 weld data logging, optional remote Bluetooth, GPS & Satellite communication, and GPS. Hydraulic open/close/locking clamps, heating plate and facing tool without operator contact.

Clamps, heating plate and facing tool cannot crash. Butt welding between clamps 2 & 3 or 3 & 4 for fittings, fabrications etc..

Australian designed and manufactured, the toughest and arguably most easily operated HDPE pipe welding machine on the market.

PolyForce630/24 CNC reduces welding time and workload on remote sites, allowing superb quality control, and faster, more efficient butt fusion of PE and PP pipelines.

Practical design with the ability to butt weld HDPE pipe





at both high and low pressure.
 Manual or CNC operation, hydraulically lifted facing tool and heating plate, hydraulic controls and pump all on-board the main frame.
 Hydraulic open/close/locking of pipe clamps - with crash protection and without operator contact during operation. Easy pipeline, trench or workshop butt fusion machine, supplied complete and ready to weld from 315 to 630mm / 8" or 12" to 24" diameter pipes and fittings between clamps 3 & 4 for tight work, plus high quality and sturdy construction provides an excellent platform for pipeline welding.
 Worldpoly PolyForce630/24 CNC is specifically designed for use in rugged and remote terrain, available in tracked, wheeled or basic options, easily operated CNC or manual control with operator safety well considered, and includes 5000 weld data logger.
 Standard pricing includes all diameter clamps and stub device.
 PolyForce630 CNC. Today's HDPE fusion welder to take your business to the next level.

TECHNICAL SPECIFICATIONS

- PolyForce630/24 Trench - Australian Made
 - Genuine 5 year international warranty
 - Hydraulic in/out facing tool and heating plate with crash protection. No longer are these considered consumables
 - Hydraulic open/close/locking of main clamps without operator contact
 - Simple operation. Automatic or manual. Integral 5000+ weld data logger
 - Bosch Rexroth hydraulics for highest quality and local serviceability
 - Pipe clamps prevent slippage even under extreme conditions. Machine detection of pipe slippage in case of significantly undersized pipe.
 - External hydraulic pipe lifters front and rear
 - Self-contained welding unit easily moved for site and trench work
 - Built tough, locally serviceable, low-noise. Just what you've been looking for
 - Capacity 315 to 630mm OD. Two-piece clamp inserts for pipe and fittings diameters 630, 560, 500, 450, 400, 355, 315, 280, 250 & 225mm (or 24" to 8").
 - Hydraulics and controls - Bosch Rexroth, locally serviceable
 - Welded steel welding machine frame
 - Rated lifting points on welding machine and frame. Optional spreader bar
 - Maximum pump operating pressure - 200 bar / 20 MPa
 - Total cylinder section - 3660mm²
 - Weight - 1400 kg
- Technical specifications subject to change without notice. Please check at time of order confirmation.



PolyForce630/24 CNC AllTerrain

**Worldpoly PolyForce630/24 CNC AllTerrain Fusion Machine.
Australian Made.**

The fastest, safest, most consistent butt welding machine available. Thanks to 3 years of research and development with Bosch Rexroth and Worldpolys' 50+ years of PE pipeline experience, every weld is the same. PolyForce630 CNC gives you complete control over welding by removing operator variables.

Providing both high and low pressure welding to ASTM, ISO, Australian/New Zealand, DVS, WIS and Fast Weld, Fast Fusion compatible.

Fully automatic heating, changeover and cooling cycle following entry of welding standard, pipe diameter and wall thickness or SDR, automatic detection of pipe slippage, hands-free hydraulic open/close/locking of main clamps.

Heavy duty all-terrain trolley with offset steering for pipeline use and disc brakes.

Intuitive CNC controls easier to use than a smart-phone, impossible to crash clamps with facing tool or heating plate, 4 second automatic changeover after heating, the safest machine on the market with keyed hydraulic lockout and Cat-3 E-stops, restricted operator entry to potential danger zones, internal 5,000 weld data logger, three speed rubber tracks, cordless remote control, external pipe lifters, and the ability to collect and communicate data externally, this is today's way to weld PE and PP pipe systems from 630mm to 225mm, or 24" to 8".

Today's fusion machine to take your business to the next level.

TECHNICAL SPECIFICATIONS

PolyForce630 AllTerrain - Australian Made

Genuine 5 year international warranty

All-terrain heavy duty wheeled base

Hydraulic in/out facing tool and heating plate with crash protection. No longer are these considered consumables

Hydraulic open/close/locking of main clamps without operator contact

Simple operation. Automatic or manual. 5000+ weld data logging as standard

Bosch Rexroth hydraulics for highest quality and local serviceability

Pipe clamps prevent slippage even under extreme conditions. PLC automatically measures drag, and detects slippage

External hydraulic pipe lifters front and rear

Self-contained welding unit easily removed for site and trench work

Built tough, locally serviceable. Just what you've been looking for

Capacity 255 to 630mm OD. Two-piece clamp inserts for pipe and fittings diameters 630, 560, 500, 450, 400, 355, 315, 280, 250 & 225mm,



and stub device, are included.

Welded steel machine frame and heavy duty wheeled base

Disk brakes.

Rated lifting points on welding machine and frame, spreader bar included

Maximum pump operating pressure - 200 bar / 20 MPa

Total cylinder section - 3660mm²

Weight - 1800 kg

Technical specifications subject to change without notice. Please check at time of order confirmation.

Specifications are subject to change without notice. Please confirm at time of purchase.



PolyForce630/24 CNC Track

Worldpoly PolyForce630/24 CNC Track.
Australian Made.

The fastest, safest, most consistent and economical butt welding machine available. Thanks to 3 years of research and development with Bosch Rexroth and Worldpolys' 50+ years of PE pipeline experience, every weld is the same. PolyForce630 CNC gives you complete control over welding by removing operator variables. Providing both high and low pressure welding to ASTM, ISO, Australian/New Zealand, DVS, WIS and Fast Weld, Fast Fusion compatible.

Fully automatic heating, changeover and cooling cycle following entry of welding standard, pipe diameter and wall thickness or SDR, automatic detection of pipe slippage, hands-free hydraulic open/close/locking of main clamps.

Intuitive CNC controls easier to use than a smart-phone, impossible to crash clamps with facing tool or heating plate, 4 second automatic changeover after heating, the safest machine on the market with keyed hydraulic lockout and Cat-3 E-stops, restricted operator entry to potential danger zones, internal 5,000 weld data logger, three speed rubber tracks, cordless remote control, external pipe lifters, and the ability to collect and communicate data externally, this is today's way to weld PE and PP pipe systems from 630mm to 225mm, or 24" to 8".

Today's fusion machine to take your business to the next level.

TECHNICAL SPECIFICATIONS

PolyForce630/24 Tracked HDPE Fusion Machine - Australian Made

Track mounted. Self contained and self propelled

Genuine 5 year International warranty

CNC welding according to the following Standards:

- ISO 21307-2011 Single Low Pressure

- ISO 21307-2011 Dual Low Pressure

- ISO 21307-2011 Single High Pressure

- POP003 Single Low Pressure

- POP003 Dual Low Pressure

- POP003 Single High Pressure

- DVS 2207-1-2007

- WIS 4-32-08 Single Pressure Welding

- WIS 4-32-08 Dual Pressure Welding

- WIS 4-32-08 UKWIR Fastweld

Hydraulic in/out facing tool and heating plate with crash protection. No longer are these considered consumables



Hydraulic open/close/locking of main clamps without operator contact. Impossible to crash main clamps with facing tool and heating plate.

Perkins on-board, low-noise, low fuel consumption 1500 RPM generator. 65 dB at operator position

Simple operation. Automatic or manual butt fusion. 5000+ weld data logging included. 3.5 second changeover time for 630mm (24") SDR 11 in Automatic mode

Bosch Rexroth hydraulics - locally serviceable. Remote communication options using GSM, Satellite and Bluetooth. GPS compatible

Pipe clamps prevent slippage even under extreme conditions, which is detected by the machine in case of undersized pipe

External hydraulic pipe lifters front and rear

Italian track assembly, Bridgestone rubber tracks, three-speed, 30+ degree capacity, automatic braking when stopped

Butt welding unit easily removed for site and trench work

Long operating time thanks to 1500 RPM low-noise diesel - 18 to 25 hours under normal welding conditions

Built tough, locally serviceable, low-noise. Just what you've been looking for

Clamp options:

Capacity 225 to 630mm OD. Includes two-piece clamp inserts for pipe and fittings diameters 630, 560, 500, 450, 400, 355, 315, 280, 250 & 225mm, and stub device, are included.

Alternatively, capacity 8" to 24" IPS. Two-piece clamp inserts for pipe and fittings diameters 24", 22", 20", 18", 16", 14", 12", 10" & 8", and stub device, are included

Electric start with remote start and fuel gauge on operator side

Welded steel machine frame and tracked base

Wired remote control. Optional wireless remote with drop and tilt protection

Rated lifting points on welding machine and frame, optional spreader bar

Maximum pump operating pressure - 200 bar / 20 MPa

Total cylinder section - 3660mm²

Fuel capacity - 70 litres

Engine - Perkins 2216 cc, 4 cylinder turbo, 1500 RPM low-noise diesel

Weight - 3400 kg

Technical specifications subject to change without notice. Please check at time of order confirmation.



PolyForce1000/40 CNC Trench

Worldpoly PolyForce1000/40 Trench.

High and low pressure welding.

Hydraulic open/close/locking clamps with crash protection.

Tracked, AllTerrain or Trench.

Intuitive CNC or manual control. 2000 weld data logging when selected.

Hydraulic open/close heating plate and facing tool.

Bosch Rexroth hydraulics for easy local service.

Weld between clamps 2 & 3 or 3 & 4.

Australian engineered, the toughest and arguably most easily operated machine on the market.

PolyForce1000/40 reduces welding time and workload on remote sites, allowing faster, more efficient welding of PE and PP pipelines. Under the correct site conditions, high pressure welding of PE pipe can reduce welding time by up to 50%.

Practical design with the ability to weld at both high and low pressure, manual or CNC operation, hydraulically lifted facing tool and heating plate, hydraulic controls and pump all on-board the main frame. Hydraulic open/close/locking of pipe clamps - with crash protection and without operator contact during operation. Easy trench welding, supplied complete and ready to weld from 500 to 1000mm or 20" to 40" diameter pipes and fittings between clamps 2 & 3, or 3 & 4 for tight work, plus high quality and sturdy construction provides an excellent machine for pipeline welding. Born from more than 50 years and three generations of experience with PE pipe, and having clients in more than 100 countries, Worldpoly manufactures the PolyRover and PolyForce range to provide a single platform for welding, according to high and low pressure standards. Worldpoly PolyForce1000/40 Trench is specifically designed for use in rugged and remote terrain, available in tracked, wheeled or trench options, easily operated CNC or manual control with operator safety well considered, and is pre-wired for the attachment of Worldpoly or other data loggers. Standard pricing includes all diameter clamps and stub device.

TECHNICAL SPECIFICATIONS

As PolyForce1000 AllTerrain, without trolley

For Indication Only



PolyForce1000/40 CNC AllTerrain

Worldpoly PolyForce1000/40 AllTerrain.

High or low force welding.

Intuitive CNC control, 2000 weld data logging as standard.

Hydraulic open/close/locking clamps with crash protection.

Hydraulic open/close in/out heating plate and facing tool.

Bosch Rexroth hydraulics for easy local service.

Weld between clamps 2 & 3 or 3 & 4.

Australian engineered, the toughest and arguably most easily operated machine on the market.

PolyForce1000/40 AllTerrain reduces welding time and workload on remote sites, allowing faster, more efficient welding of PE and PP pipelines. Under the correct site conditions, high or low pressure welding of PE pipe can reduce welding time by 50%.

Practical design with the ability to weld at high force, CNC operation, hydraulically lifted facing tool and heating plate, hydraulic controls and pump all on-board the main frame. Hydraulic open/close/locking of pipe clamps - with crash protection and without operator contact during operation. Easy trench welding, supplied complete and ready to weld from 500 to 1000mm or 20" to 40" diameter pipes and fittings between clamps 2 & 3, or 3 & 4 for tight work, plus high quality and sturdy construction provides an excellent machine for pipeline welding.

Born from more than 50 years and three generations of experience with PE pipe, a three year research and development program with Bosch Rexroth, and having clients in more than 100 countries, Worldpoly manufactures the PolyRover and PolyForce range to provide a single platform for welding, according to high and low pressure standards.

Worldpoly PolyForce1000/40 AllTerrain is specifically designed for use in rugged and remote terrain, available in tracked, wheeled or trench options, easily operated CNC control with operator safety well considered, and data logging as standard. Standard pricing includes all diameter clamps and stub device.

TECHNICAL SPECIFICATIONS

PolyForce1000 Australian Engineered Butt Welding Machine, including on-board hydraulic pump, controls, hydraulically movable facing tool and heating plate, hydraulic open/close/locking of pipe clamps

Provides high or low pressure welding operation.

Welding operation by CNC, includes 2000 weld data logging.

Genuine 5 year international warranty.

- Welding range 500 to 1000mm SDR11, according to DVS, ISO and AUS/NZ POP003 high and low force specifications.



- Easily able to weld between clamps 3 and 4 for tight fittings and fabrications.
- Entire welding frame with 4 clamps and complete hydraulic system easily removed for trench work, allowing accurate alignment.
- Fork lift and overhead lifting points.

Includes two-piece reducing liners to weld pipe within the complete specified range:

- Metric – 1000, 900, 800, 710, 630, 560 and 500mm OD.
- Optional inch clamps 42", 36", 32", 28", 24", 22" & 20".

Hydraulic open/close/locking of pipe clamps with clamp crash protection, and no operator contact during operation.

Hydraulically lifted cast Aluminium PTFE coated heating plate with electronic temperature control and insulated cover.

Hydraulically lifted and electrically operated cast Aluminium electric facing tool, with current overload protection.

High quality and remotely serviceable Bosch Rexroth electro-hydraulic pump, PLC, valves and controls.

Operating voltage 400 volt 3 phase 50 Hz (30.8 kw, 50.2 A). Optional 60 Hz also available.

Intuitive modular controls located in convenient operator position include:

- Bosch Rexroth hydraulics.
- Pipe clamps open, close and lock without operator contact. Ideal for Occupational Health and Safety requirements.
- 2 x Emergency stops.
- Choice of CNC or manual welding operation .

Optional tracked base is easily removed for trench use, and doubles as a worksite work-horse featuring:

- Two-speed heavy duty rubber tracks.
- Perkins low-noise diesel generator
- Both cordless and wired remot controls.
- Remote engine start on operator side.
- LED head, tail and warning lights.
- Rated lifting points and cross-bar.

Steerable wheeled base readily removable for trench work.

- High quality wide profile all-terrain wheels and tyres.
- Hydraulic pipe lifters front and rear.
- Offset steering.
- Not road registerable.

Supplied with the machine:

- Two-piece clamps for welding 1000, 900, 800, 710, 630, 560 and 500mm OD pipes and fittings, or IPS equivalent.
- Stub end device for welding end fittings (available in Aluminium or Steel)
- Tool box including spare blades, thermocouple, temperature controller, tools etc
- In-trench welding kit

Please note technical specifications of Worldpoly machines may change without notice. Please confirm at time of order.



PolyForce1000/40 CNC Track

Worldpoly PolyForce1000/40 Track.

High and low pressure butt welding machine including on-board hydraulic pump, intuitive CNC or manual controls, hydraulically movable facing tool and heating plate, hydraulic open/close/locking of pipe clamps, aluminium stub device and 4 circles of two-piece clamps 1000mm to 500mm / alt. 40" to 18".

Tracked base includes low-noise Perkins diesel generator, three speed rubber tracks, remote control, external hydraulic pipe lifters etc.

TECHNICAL SPECIFICATIONS

PolyForce1000/40 Tracked - Australian Made

Track mounted, self contained and self propelled

Hydraulic in/out facing tool and heating plate with crash protection. No longer are these considered consumables

Hydraulic open/close/locking of main clamps without operator contact

Perkins on-board low-noise low fuel consumption 1500 RPM generator. Less than 60 dB at operator position.

Simple operation. Automatic or manual. 5000+ weld data logging

Bosch Rexroth hydraulics - locally serviceable

Pipe clamps provide prevent slippage even under extreme conditions

External hydraulic pipe lifters front and rear

Tracked base completely self-contained for use as utility vehicle on-site

Self-contained welding unit easily removed for site and trench work

Long operating time thanks to 1500 RPM low-noise diesel - 18 to 25 hours under normal welding conditions

Built tough, locally serviceable, low-noise. Just what you've been looking for

Specifications:

Capacity 500 to 1000mm OD / alternatively 40" to 18". Two-piece clamp inserts for pipe and fittings diameters 1000, 900, 800, 710, 630, 560 and 500mm, and stub device, are included

Electric start with remote start on operator side

Welded steel welding machine frame and tracked base

Italian track assembly, rubber tracks, three-speed, 30+ degree capacity, automatic braking when stopped

Optional wireless remote control. Wired emergency control

Rated lifting points on welding machine and frame, spreader bar included

Maximum pump operating pressure - 200 bar / 20 MPa



Fuel capacity - 70 litres / 20 hours

Engine - Perkins 2216 cc, 4 cylinder turbo, 1500 RPM low-noise diesel

Weight - 5400 kg

Technical specifications subject to change without notice. Please check at time of order confirmation.



PolyTrack

Worldpoly PolyTrack provides a tough, economical and low-noise tracked platform for the worksite. Fitted with a Cummins Onan 1500 RPM 17 KVa low-noise marine diesel generator, Bosch Rexroth hydraulics, both cordless and wired remote control and Italian two-speed rubber tracks, PolyTrack combines experience with real requirements and Occupational Health and Safety considerations. PolyTrack immediately accepts both Worldpoly PolyForce630 Automatic and PolyForce1000 Automatic welding machines.

TECHNICAL SPECIFICATIONS

Worldpoly PolyTrack tracked base

Australian Made - extremely rugged construction

Perkins 1500 RPM low-noise 20 KVA electric start diesel generator with remote start. 64 dB at operator position

Bosch Rexroth hydraulics - locally serviceable

Italian tracks

Cordless and wired remote controls

LED head, tail and warning lights

Rated lifting points fitted, and spreader bar available as optional extra

3 year warranty on hydraulics, 1 year manufacturers warranty on generator and tracks

Specifications subject to change without notice. please confirm at time of order.



PolyBasic 160

A manually operated butt-welding machine suitable for PE and PP pipes and fittings from 40 to 160mm OD. Efficient design and construction provides an excellent low cost machine for welding both on the worksite and in the factory. The use of high quality Aluminium castings allows for lower weight without compromising strength and performance. Optional torque wrench allows welding force to be read.



TECHNICAL SPECIFICATIONS

Welding range 40 to 160mm: 40 to 63mm - SDR7.4 to SDR 11. 75mm to 90mm - SDR 9 to SDR 17. 110mm to 160mm SDR 11 to SDR 41

Complete and ready to weld.

Genuine 12 months international warranty.

Main frame includes light weight alloy main clamps of 160mm diameter.

Layer clamps 160x140, 140x125, 125x110, 110x90, 90x75, 75x63, 63x50 & 50x40mm.

Removable cast Aluminum PTFE coated heating plate with electronic temperature control.

Removable cast Aluminum electrically operated facing tool.

Stand for heating plate and facing tool.

Manual opening of frame. Optional torque wrench for measurement of welding force.

230 volt 50/60 Hz (2.2 kw 11.1 A).

Requires generator minimum 2.3 KVA.

Weight 77kg

Note - This unit does not accurately read force below 20N/mpa. Drag + welding force must equal minimum 20N/mpa for accurate welding.

Not recommended for welding pressure pipe

Please note technical specifications of Worldpoly machines may change without notice



Worldpoly160

Worldpoly160 hydraulically operated butt-welding machine suitable for PE and PP pipes and fittings from 50 to 160mm OD using low force welding methods. Excellent Australian Engineered design and construction provides a premium machine for welding both on the worksite and in the factory. The use of high quality pressure-cast Aluminium castings allows for lower weight without compromising strength and performance, while providing extra strength when welding out-of-round pipe. Significantly increased force is available for drag when welding pipe strings, or on difficult sites. Welding can be carried out between clamps 3 & 4 for tees, bends and manifold work. Can be immediately integrated with optional data logger.



TECHNICAL SPECIFICATIONS

Welding range 50 to 160mm: SDR 9 (PN20) to SDR 41 (PN4) according to DVS 2207-1, ISO 21307 and POP003 low-pressure specifications

Complete and ready to weld - Genuine 2 year warranty on parts - CE approved by SGS www.sgs.com

Included as standard (unless otherwise specified):

- Main frame, including 4 light weight pressure-cast alloy main clamps of 160mm diameter
- Removable cast Aluminium electric facing tool with current overload protection
- Electrohydraulic pump with controls, and quick release hoses. Includes countdown timers for heating and cooling phases
- PTFE coated heating plate with electronic temperature control (heating plate automatically separates from pipe ends after heating)
- Stand for heating plate and facing tool
- Tool box including tools, bolts, selected spare parts, etc
- German hydraulic seals
- Wired ready to accept Worldpoly or other data logger

Clamp options include (machine can be supplied with any combination of liner diameters):

- Layer clamps: 160x140, 140x125, 125x110, 110x90, 90x75, 75x63 & 63x50mm
- 2-piece liners: 160x140, 160x125, 160x110, 160x90, 160x75, 160x63 & 160x50mm
- Narrow clamps: 160x140, 160x125, 160x110, 160x90, 160x75, 160x63 & 160x50mm

Optional stub end device for welding end fittings (available in aluminium or steel)

Optional wheeled trolley available

230 volt 50/60 Hz (2.78 kw 14.8A)

Requires generator minimum 230 volt 3.3 KVA - provide full machine details to generator supplier before purchase

Total cylinder section 6.26 cm², maximum pump pressure 60 bar

Weight 156kg

Please note technical specifications of Worldpoly machines may change without notice

Australia only - This machine is supplied tested & tagged with a 15amp plug



Worldpoly250

Worldpoly250 hydraulically operated butt-welding machine suitable for PE and PP pipes and fittings from 50 to 250mm OD. Excellent design and construction provides a premium machine for welding both on the worksite and in the factory. The use of high quality pressure-cast Aluminium castings allows for lower weight without compromising strength and performance, while providing extra strength when welding out-of-round pipe. Welding can be carried out between clamps 3 & 4 for tees, bends and manifold work. Can be immediately integrated with optional data logger.



TECHNICAL SPECIFICATIONS

Welding range 50 to 250mm: SDR 9 (PN20) to SDR 41 (PN4) according to DVS 2207-1, ISO 21307 and POP003 low-pressure specifications.

Complete and ready to weld.

Genuine 2 year international warranty

German hydraulic seals.

CE approved by SGS www.sgs.com

Main frame includes 4 light weight pressure-cast alloy main clamps of 250mm diameter.

Machine can be supplied with any combination of liner diameters. Clamp options include:

Layer clamps: 250x225, 225x200, 200x180, 180x160, 160x140, 140x125, 125x110, 110x90, 90x75, 75x63 & 63x50.

2-piece liners: 250x225, 250x200, 250x180, 250x160, 250x140, 250x125, 250x110, 250x90, 250x75, 250x63 & 250x50.

Narrow clamps: 250x225, 250x200, 250x180, 250x160, 250x140, 250x125, 250x110, 250x90, 250x75, 250x63 & 250x50.

Removable cast Aluminium PTFE coated heating plate with electronic temperature control. Heating plate automatically separates from pipe ends after heating

Electrically operated facing tool for the preparation of pipe ends.

Stand for heating plate and facing tool.

Electro hydraulic pump with controls, and quick release hoses. Includes countdown timers for heating and cooling phases.

Tool box including tools, bolts etc.

Optional stub end device for welding end fittings (available in aluminium or steel).

Wired ready to accept Worldpoly or other data logger.

Optional wheeled trolley available.

230V 50/60 Hz, 3.95kW, 17.2 Amps.

Requires generator minimum 5 KVA. Provide full machine details to generator supplier before purchase.

Total cylinder area: 11cm², maximum pump pressure 60 bar

Total weight 166kg

Please note technical specifications of Worldpoly machines may change without notice



Worldpoly315

Worldpoly315 hydraulically operated HDPE pipe butt welding machine, suitable for PE and PP pipes and fittings from 90 to 315mm OD. Butt welding can be carried out between clamps 3 & 4 for tees, bends and manifold work, and the fusion machine can be immediately integrated with optional data logger. Able to cope with out-of-round pipe and less than perfect site conditions better than the Europeans, and with parts and service readily available, Worldpoly315 poly pipe fusion machine will be providing you with excellent service for years. Worldpoly315 HDPE welding machine. When you want a polyethylene pipe fusion machine that will provide excellent HDPE pipe fusion for years, but don't want to pay a fortune.



TECHNICAL SPECIFICATIONS

Welding range 90 to 315mm SDR 9 (PN20) to SDR 41 (PN4) according to DVS 2207-1, ISO 21307 and POP003 low-pressure specifications.

Complete and ready to weld - Genuine 2 year warranty on parts - CE approved by SGS www.sgs.com

Included as standard (unless otherwise specified):

- Main frame, including 4 light weight pressure-cast alloy main clamps of 315mm diameter
- Removable cast Aluminium electric facing tool with current overload protection
- Electrohydraulic pump with controls, and quick release hoses. Includes countdown timers for heating and cooling phases
- PTFE coated heating plate with electronic temperature control and electric facing tool
- Stand for heating plate and facing tool.
- Tool box including tools, bolts, selected spare parts, etc
- Wired ready to accept Worldpoly or other data logger.

Clamp options include (machine can be supplied with any combination of liner diameters):

- Layer clamps: 315x280, 280x250, 250x225, 225x200, 200x180, 180x160, 160x140, 140x125, 125x110, 110x90.
- 2-piece liners: 315x280, 315x250, 315x225, 315x200, 315x180, 315x160, 160x140, 160x125, 160x110, 160x90.
- Narrow clamps: 315x280, 315x250, 315x225, 315x200, 315x180, 315x160, 315x140, 315x125, 315x110, 315x90.

Optional Aluminium or steel stub end device for butt welding end fittings. Optional wheeled trolley available.

230 volt 50/60 Hz, 5.0 kw, 15 A.

Requires generator minimum: 230 volt - 7 KVA. Provide full machine details to generator supplier before purchase.

Total cylinder area: 20cm² / 2000mm², maximum pump pressure 60 bar

Weight 355kg

Please note technical specifications of Worldpoly machines may change without notice

Australia only - This machine is supplied tested & tagged with 1x 15 and 1 x 10 amp plugs requiring two power supplies



Worldpoly315 High Pressure

High and low-pressure welding. Worldpoly 315 / 12" High Pressure is a hydraulically operated butt-welding machine suitable for PE and PP pipes and fittings from 90 to 315mm OD (alternatively 3" to 12" IPS), using both high and low pressure welding methods. Excellent Australian Engineered design and construction provides a premium machine for welding both on the worksite and in the factory. The use of high quality construction allows for lower weight without compromising strength and performance, while providing extra strength when welding out-of-round pipe. Significantly increased force is available for drag when welding pipe strings, or on difficult sites. Welding can be carried out between clamps 3 & 4 for tees, bends and manifold work, and the machine is pre-wired for immediate integration with optional data logger.

TECHNICAL SPECIFICATIONS

Welding range 90 to 315mm SDR 9 (PN20) to SDR 17. 90 to 160mm SDR 9 and 11 only.

Welds both high and low pressure according to ISO, ASTM, ANZ POP003, and DVS low pressure.

Complete and ready to weld pipe and fittings diameters 315, 280, 250, 225, 200, 180, 160, 140, 125, 110 and 90mm OD (excluding liners).

German hydraulic seals.

Genuine 24 month international warranty.

Electro-hydraulic pump with controls, and quick release hoses.

Removable cast Aluminum PTFE coated heater plate with electronic temperature control. Heating plate automatically separates from pipe ends after heating.

Electrically operated facing tool for correct preparation of pipe ends.

Stand for heating plate and facing tool.

Tool box including tools, bolts etc.

Easily welds between clamps 3 and 4 for tees, fabrications and tight welds. Low pressure welding only when using single clamp.

Wired ready to accept Worldpoly or other data logger.

Clamp options include:

- 2-piece liners: 315x280, 315x250, 315x225, 315x200, 315x180, 315x160, 160x140, 160x125, 160x110, 160x90.

- Steel stub device

- Narrow clamps: 315x280, 315x250, 315x225, 315x200, 315x180, 315x160, 315x140, 315x125, 315x110, 315x90.

- Inch clamps.

230 volt, single phase, 50/60 hz. 6.2 kw, 19.8 A. Uses 2 x 15 A input leads.

Minimum generator required: 230 volt - 7 KVA. Provide full machine details to generator supplier before purchase.

Total cylinder area: 20.0 cm² / 2000 mm².

Please note that the Worldpoly High Force machines are not certified under CE requirements.

Weight 355kg.

Specifications are subject to change without notice. Please confirm at time of purchase.



Worldpoly315 CNC

Worldpoly315 CNC hydraulically operated butt-welding machine suitable for PE and PP pipes and fittings from 90 to 315mm OD. Excellent design and construction provides a premium machine for welding both on the worksite and in the factory. Integrated CNC control ensures correct welding procedures including temperature, time and pressure functions. The use of high quality pressure-cast Aluminium castings allows for lower weight without compromising strength and performance, while providing extra strength when welding out-of-round pipe. Welding can be carried out between clamps 3 & 4 for tees, bends and manifold work. Includes integrated data logger.

TECHNICAL SPECIFICATIONS

Welding range 110 to 315mm SDR 9 (PN20) to SDR 41 (PN4) according to DVS 2207-1 and ISO 21307 low-pressure specifications.

Complete and ready to weld.

CNC controlled temperature, time and pressure functions.

Supplied with a full set of 2-piece liners: 315x280, 315x250, 315x225, 315x200, 315x180, 315x160, 160x140, 160x125, 160x110, 160x90.

CNC controlled electro hydraulic pump with quick release hoses.

CNC controlled hydraulically inserted and removed cast Aluminum PTFE coated heated plate, with electronic temperature control. Heating plate automatically separates from pipe ends after heating.

Hydraulically inserted and removed electrically operated facing tool for correct preparation of pipe ends.

Optional Aluminium or steel stub end device for welding end fittings.

integrated data logger with USB output.

Genuine international warranty.

230 volt 50 Hz, 5.0 kw, 15 A. Optional 60 Hz also available.

Total cylinder area:

Weight 355kg

Please note technical specifications of Worldpoly machines may change without notice. Please reconfirm at time of order confirmation.



Worldpoly450

Worldpoly450 hydraulically operated butt-welding machine suitable for PE and PP pipes and fittings from 200 to 450mm OD (modification available to weld to 160mm SDR 9 & 11 only). Excellent design and construction provides a premium machine for welding both on the work site and in the factory. The use of high quality pressure-cast Aluminium castings allows for lower weight without compromising strength and performance, while providing extra strength when welding out-of-round pipe. Welding can be carried out between clamps 3 & 4 for tees, bends and manifold work. Can be immediately integrated with optional data logger and overhead electric crane.



TECHNICAL SPECIFICATIONS

Welding range 200 to 450mm: SDR 9 (PN20) to SDR 41 (PN4) according to DVS 2207-1, ISO 21307 and POP003 low-pressure specifications.

Complete and ready to weld.

CE approved by SGS www.sgs.com

German hydraulic seals.

Main frame includes 4 light weight pressure-cast alloy main clamps of 450mm diameter.

Machine can be supplied with any combination of liner diameters. Clamp options include:

Layer clamps: 450x400, 400x355, 355x315, 315x280, 280x250, 250x225, 225x200.

2-piece liners: 450x400, 450x355, 450x315, 450x280, 315x250, 315x225, 315x200.

Narrow clamps: 450x400, 450x355, 450x315, 450x280, 450x250, 450x225, 450x200.

Removable cast Aluminium PTFE coated heating plate with electronic temperature control. Heating plate automatically separates from pipe ends after heating.

Removable cast Aluminium electric facing tool with current overload protection.

Electrohydraulic pump with controls, and quick release hoses. Includes countdown timers for heating and cooling phases.

Stand for heating plate and facing tool.

Optional Aluminium or steel stub end device for welding end fittings, 250kg capacity crane assembly & wheeled trolley available

Tool box including tools, bolts etc.

Genuine 2 year international warranty.

Wired ready to accept Worldpoly or other data logger.

400V 3 phase 50/60 Hz (10.5 kw 17 A) alt 220 volt 50/60 hz (9.8 kw 22.9 A)

Minimum generator required: 400 volt 3 phase 14 KVA (alt 230 volt 1 phase 13 KVA). Provide full machine details to generator supplier before purchase.

Weight 776kg (including crane and stub device)

Total cylinder area: 22.36cm², maximum pump pressure 120 bar

Please note technical specifications of Worldpoly machines may change without notice

Worldpoly450 High Pressure

High and low-pressure welding. Worldpoly450 High Pressure is a hydraulically operated butt-welding machine suitable for PE and PP pipes and fittings from 200 to 450mm OD, using both high and low pressure welding methods. Excellent Australian Engineered design and construction provides a premium machine for welding both on the worksite and in the factory. The use of high quality pressure-cast Aluminium clamps allows for lower weight without compromising strength and performance, while providing extra strength when welding out-of-round pipe. Significantly increased force is available for drag when welding pipe strings, or on difficult sites. Welding can be carried out between clamps 3 & 4 for tees, bends and manifold work, and the machine is pre-wired for immediate integration with optional data logger, and overhead electric crane.



TECHNICAL SPECIFICATIONS

Welding range 200 to 450mm SDR 9 (PN20) to SDR 17. 200 to 250mm SDR 9 and 11 only.

Welds both high and low pressure according to ISO, ASTM, ANZ POP003, and DVS low pressure.

Complete and ready to weld pipe and fittings diameters 450, 400, 355, 315, 280, 250, 225 and 200mm OD.

German hydraulic seals.

Genuine 24 month international warranty.

Supplied with complete set of Aluminium cast two-piece liners 450x400, 450x355, 450x315, 450x280, 315x250, 315x225, 315x200.

Electro-hydraulic pump with controls, and quick release hoses.

Removable cast Aluminum PTFE coated heating plate with electronic temperature control. Heating plate automatically separates from pipe ends after heating.

Electrically operated facing tool for correct preparation of pipe ends.

Stand for heating plate and facing tool.

Includes Aluminium stub end device for welding end fittings.

Tool box including tools, bolts etc.

Easily welds between clamps 3 and 4 for tees, fabrications and tight welds. Low pressure welding only when using single clamp.

Wired ready to accept Worldpoly or other data loggers.

Clamp options include:

- Narrow clamps: 450x400, 450x355, 450x315, 450x280, 450x250, 450x225, 450x200.

- Inch clamps.

Optional overhead electric crane. Check requirements for crane approval regarding your specific application.

400V 3 phase 50/60 Hz (10.5 kw 18.4 A).

Minimum generator required: 400 volt 3 phase 11 KVA (alt 230 volt 1 phase 11 KVA). Provide full machine details to generator supplier before purchase.

Total cylinder area: 22.36 cm² / 2236 mm²

Please note that the Worldpoly High Force machines are not certified under CE requirements.

Weight 776kg (including crane and stub device)

Specifications are subject to change without notice. Please confirm at time of purchase.



Worldpoly500

Worldpoly500 hydraulically operated butt-welding machine suitable for PE and PP pipes and fittings from 200 to 500mm OD. Excellent design and construction provides a premium machine for welding both on the worksite and in the factory. The use of high quality pressure-cast Aluminium castings allows for lower weight without compromising strength and performance, while providing extra strength when welding out-of-round pipe. Welding can be carried out between clamps 3 & 4 for tees, bends and manifold work. Can be immediately integrated with optional data logger and overhead electric crane.



TECHNICAL SPECIFICATIONS

Welding range 200mm to 500mm: SDR 9 (PN20) to SDR 41 (PN4) according to DVS 2207-1, ISO 21307 and POP003 low-pressure specifications..

Complete and ready to weld.

German hydraulic seals.

Main frame includes 4 light weight pressure-cast alloy main clamps of 500mm diameter.

Machine can be supplied with any combination of liner diameters.

Layer clamps: 500x450, 450x400, 400x355, 355x315, 315x280, 280x250, 250x225 & 225x200

2-piece clamps: 500x450, 500x400, 500x355, 500x315, 315x280, 315x250, 315x225 & 315x200

Narrow clamps: 500x450, 500x400, 500x355, 500x315, 500x280, 500x250, 500x225 & 500x200.

Removable cast Aluminium PTFE coated heated plate with electronic temperature control. Heating plate automatically separates from pipe ends after heating.

Removable cast Aluminium electric facing tool with current overload protection.

Stand for heating plate and facing tool.

Electro hydraulic pump with controls, and quick release hoses. Includes countdown timers for heating and cooling phases.

Optional Aluminium or steel stub end device for welding end fittings.

Genuine 2 year International warranty.

Wired ready to accept Worldpoly or other data logger.

Tool box including tools, bolts etc.

Optional wheeled trolley available.

Optional 250kg crane assembly.

400 volt 3 phase 50/60 Hz (11.2 kw 18 A).

Minimum generator required: 400 volt 15 KVA. Provide full machine details to generator supplier before purchase.

Weight 592kg (including crane and stub device)

Total cylinder area: 23.06cm² (2306mm²)

Please note technical specifications of Worldpoly machines may change without notice



Worldpoly630

Worldpoly630 hydraulically operated butt welding machine suitable for HDPE and PP pipes and fittings from 315 to 630mm OD / 12" to 24". Excellent design and construction provides a premium machine for butt welding both on the worksite and in the factory.

The use of high quality pressure-cast Aluminium castings allows for lower weight without compromising strength and performance, while providing extra strength when welding out-of-round pipe. Welding can be carried out between clamps 3 & 4 for tees, bends and manifold work. Can be immediately integrated with optional data logger and overhead electric crane.

Worldpoly630. CE approved by the Swiss. This is the HDPE pipe butt welding machine to invest in when you want it to be with you reliably for years, without spending a fortune.

TECHNICAL SPECIFICATIONS

Welding range 315mm to 630mm: SDR 9 (PN20) to SDR 41 (PN4) according to DVS 2207-1, ISO 21307 and POP003 low-pressure specifications..

Complete and ready to weld.

CE approved by SGS www.sgs.com

German hydraulic seals.

Main frame includes 4 light weight pressure-cast alloy main clamps of 630mm diameter.

Machine can be supplied with any combination of liner diameters. Clamp options include:

Layer clamps: 630x560, 560x500, 500x450, 450x400, 400x355, 355x315.

2-piece liners: 630x560, 630x500, 630x450, 630x400, 450x355, 450x315.

Narrow clamps: 630x560, 630x500, 630x450, 630x400, 630x355, 630x315.

Removable cast Aluminium PTFE coated heated plate with electronic temperature control. Heating plate automatically separates from pipe ends after heating.

Removable cast Aluminium electric facing tool with current overload protection.

Stand for heating plate and facing tool.

Electro hydraulic pump with controls, and quick release hoses. Includes countdown timers for heating and cooling phases.

Optional Aluminium or steel stub end device for welding end fittings.

Genuine 2 year international warranty.

Wired ready to accept Worldpoly or other data logger.

Tool box including tools, bolts etc.

Optional wheeled trolley available.

Optional 250kg crane assembly.

400 volt 3 phase 50/60 Hz (14.5 kw 23 A).

Minimum generator required: 400 volt 3 phase 20 KVA. Provide full machine details to generator supplier before purchase.

Weight 1,092kg (including crane and stub device)

Total cylinder area: 23.06cm² (2306mm²), maximum pump pressure 120 bar

Please note technical specifications of Worldpoly machines may change without notice



Worldpoly800

Worldpoly800 hydraulically operated butt-welding machine suitable for PE and PP pipes and fittings from 450 (optionally 400) to 800mm OD. Excellent design and construction provides a premium machine for welding both on the worksite and in the factory. The use of high quality Aluminium castings allows for lower weight without compromising strength and performance. Welding can be carried out between clamps 3 & 4 for tees, bends and manifold work. Can be integrated with optional data logger and overhead electric crane.



TECHNICAL SPECIFICATIONS

Welding range 450 to 800mm: SDR 9 (PN20) to SDR 41 (PN4). Optional modification to 400mm SDR 11 to SDR 17

Welding force maximum 800mm OD SDR 9 plus 30% drag, according to according to DVS 2207-1, ISO 21307 and POP003 low-pressure specifications.

Complete and ready to weld.

CE approved by SGS www.sgs.com

German hydraulic seals.

Main frame includes 4 light weight alloy main clamps of 800mm diameter.

Clamp options include:

Layer clamps: 800x710, 710x630, 630x560, 560x500, 500x450.

2-piece liners: 800x710, 800x630, 630x560, 630x500, 630x450.

Narrow clamps: 800x710, 800x630, 800x560, 800x500, 800x450.

Machine can be supplied with any combination of liner diameters.

Aluminium PTFE coated heating plate with electronic temperature control.

Electrically operated facing tool for correct preparation of pipe ends.

Electro hydraulic pump with controls, and quick release hoses. Includes countdown timers for heating and cooling phases.

Stand for heating plate and facing tool.

Overhead electric crane included with standard machine (note please check crane regulations in your country for suitability).

Optional Aluminium or steel stub end device for welding end fittings.

Wired ready to accept Worldpoly or other data logger.

Genuine 2 year international warranty.

Tool box including tools, bolts etc.

Optional wheeled trolley available.

Optional 500kg crane assembly.

400 volt 3 phase 50/60 Hz (18.8 kw 29.8 A).

Minimum generator required: 400 volt 25 KVA. Provide full machine details to generator supplier before purchase.

Weight 1,720kg (including crane and stub device)

Total cylinder area: 20.4cm², maximum pump pressure 180 bar

Please note technical specifications of Worldpoly machines may change without notice



Worldpoly1000

Worldpoly1000 hydraulically operated butt-welding machine suitable for PE and PP pipes and fittings from 500 to 1000mm or 36" to 20" OD. Excellent design and construction provide a premium machine for welding both on the worksite and in the factory. The use of high quality construction allows for lower weight without compromising strength and performance. Welding can be carried out between clamps 3 & 4 for tees, bends and manifold work, and the machine is easily integrated with optional data logger and overhead electric crane.



TECHNICAL SPECIFICATIONS

Welding range 500mm to 1000mm: SDR 11 (PN16) to SDR 41 (PN4). 500 to 630 SDR 9 / alt 20" to 36" SDR 11. 22" & 24" SDR 9.

Welding force maximum 1000mm OD SDR 7.4 plus, according to DVS 2207-1, ISO 21307 and POP003 low-pressure specifications.

Complete and ready to weld.

Main frame includes 4 light weight alloy main clamps of 1000mm.

Genuine 2 year International warranty.

CE approved by SGS www.sgs.com

German hydraulic seals.

Machine can be supplied with any combination of optional liner diameters.

Layer clamps: 1000x900, 900x800, 800x710, 710x630, 710 x 560, 710 x 500.

Layer clamps 40" x 36", 36" x 32", 32" x 28", 28" x 24", 24" x 22" and 22" x 20".

Two-piece clamps 40" x 36", 40" x 32", 40" x 28", 28" x 24", 28" x 22" and 28" x 20".

Electrohydraulic pump with controls, accumulator and quick release hoses. Includes countdown timers for heating and cooling phases.

Removable cast Aluminum PTFE coated heating plate with electronic temperature control. Heating plate automatically separates from pipe

ends after heating.

Removable cast Aluminium electric facing tool with current overload protection.

Stand for heating plate and facing tool and tool box.

Optional stub end device for welding end fittings (available in aluminium or steel).

Wired ready to accept Worldpoly or other data logger.

Tool box including tools, bolts etc.

Optional 500kg / 1100lb. capacity crane assembly.

400 volt 3 phase 50/60 Hz (33.4 kw, 50 A).

Minimum generator required: 400 volt 43 KVA. Provide full machine details to generator supplier before purchase.

Weight 2,687kg (including crane and stub device)

Total cylinder area: 43.60cm², maximum pump pressure 180 bar

Please note technical specifications of Worldpoly machines may change without notice



Worldpoly1000/40 Hydra

Worldpoly1000/40 hydraulically operated butt-welding machine, suitable for PE and PP pipes and fittings from 500 to 1000mm OD / 20" to 40". The machine is the result of more than 50 consecutive years of direct involvement in the PE pipe industry, providing premium equipment for welding both on the work-site and in the factory. Hydraulic open/close/locking main clamps allow easier pipe handling, while on-board hydraulic in/out facing tool and heating plate provides a single unit for movement to, from and around site. The use of virgin Aluminium castings and German hydraulic seals allows for lower weight without compromising strength and performance. Welding can be carried out between clamps 3 & 4 for tees, bends and manifold work. Ready to accept optional data logger. High and low-force models available.

TECHNICAL SPECIFICATIONS

Welding range 500mm to 1000mm: SDR 11 (PN16) to SDR 41 (PN4). 500 to 630 SDR 9 / alt 20" to 36" SDR 11. 22" & 24" SDR 9.

Welding force maximum 1000mm OD SDR 7.4 plus, according to DVS 2207-1, ISO 21307 and POP003 low-pressure specifications.

Complete and ready to weld.

Main frame includes 4 light weight alloy main clamps of 1000mm.

Genuine 2 year International warranty.

German hydraulic seals.

Machine can be supplied with any combination of optional liner diameters.

Layer clamps: 1000x900, 900x800, 800x710, 710x630, 710 x 560, 710 x 500.

Layer clamps 40" x 36", 36" x 32", 32" x 28", 28" x 24", 24" x 22" and 22" x 20".

Two-piece clamps 40" x 36", 40" x 32", 40" x 28", 28" x 24", 28" x 22" and 28" x 20".

Electrohydraulic pump with controls, accumulator and quick release hoses. Includes countdown timers for heating and cooling phases.

Optional stub end device for welding end fittings (available in aluminium or steel).

Wired ready to accept Worldpoly or other data logger.

Tool box including tools, bolts etc.

400 volt 3 phase 50/60 Hz (33.4 kw, 50 A).

Minimum generator required: 400 volt 43 KVA. Provide full machine details to generator supplier before purchase.

Weight 2,687kg (including stub device)

Total cylinder area: 43.60cm², maximum pump pressure 180 bar

Please note technical specifications of Worldpoly machines may change without notice



Worldpoly1200

Worldpoly1200/48 hydraulically operated butt-welding machine, suitable for PE and PP pipes and fittings from 630 to 1200mm OD, alternatively 24 to 48". The machine is the result of more than 50 years of consecutive involvement in the PE pipe industry, providing a premium machine for welding both on the work-site and in the factory. The use of virgin Aluminium castings and German hydraulic seals allows for lower weight without compromising strength and performance. Welding can be carried out between clamps 3 & 4 for tees, bends and manifold work. Can be integrated with optional data logger and overhead electric crane.

TECHNICAL SPECIFICATIONS

Welding range 630 to 1200mm: SDR 11 (PN16) to SDR 41 (PN4). 630 to 800mm: SDR 9 to SDR 41.

Welding force maximum 1200mm OD SDR 11, according to DVS 2207-1, ISO 21307 and POP003 low-pressure specifications.

Complete and ready to weld.

CE approved by SGS www.sgs.com

German hydraulic seals.

Main frame includes 4 light weight alloy main clamps of 1200mm diameter.

Layer clamps: 1200x1100, 1100x1000, 1000x900, 900x800, 800x710, 710x630.

Machine can be supplied with any combination of liner diameters.

Aluminium PTFE coated heating plate with electronic temperature control. Heating plate automatically releases from pipe ends after heating.

Electrically operated facing tool for correct preparation of pipe ends.

Stand for heating plate and facing tool.

Electrohydraulic pump with controls, accumulator and quick release hoses. Includes countdown timers for heating and cooling phases.

Genuine 2 year international warranty.

Optional Aluminium or steel stub end device for welding end fittings.

Wired ready to accept Worldpoly or other data logger.

Tool box including tools, bolts etc.

Optional wheeled trolley available.

Optional 1,000kg crane assembly.

400 volt 3 phase 50/60 Hz (30.6 kw, 47.6 A).

Minimum generator required: 400 volt 3 phase 50 hz, 32 KVA. Provide full machine details to generator supplier before purchase.

Weight 4,522kg (including crane and stub device)

Total cylinder area: 32.97cm², maximum pump pressure 180 bar

Please note technical specifications of Worldpoly machines may change without notice



Worldpoly1200/48 Hydra

Worldpoly1200/48 hydraulically operated butt-welding machine, suitable for PE and PP pipes and fittings from 630 to 1200mm OD/24" to 48". The machine is the result of more than 50 consecutive years of direct involvement in the PE pipe industry, providing premium equipment for welding both on the work-site and in the factory. Hydraulic open/close/locking main clamps allow easier pipe handling, while on-board hydraulic in/out facing tool and heating plate provides a single unit for movement to, from and around site. Optional on-board diesel generator. The use of virgin Aluminium castings and German hydraulic seals allows for lower weight without compromising strength and performance. Welding can be carried out between clamps 3 & 4 for tees, bends and manifold work. Ready to accept optional data logger, and available in both low and high-force welding options.

TECHNICAL SPECIFICATIONS

Welding range 630 to 1200mm/24" to 48" IPS: SDR 11 (PN16) to SDR 41 (PN4). 630 to 800mm: SDR 9 to SDR 41.

Welding force maximum 1200mm/48" OD SDR 11, according to ISO 21307, ASTM and POP003 specifications.

Complete and ready to weld.

CE approved by SGS www.sgs.com

Hydraulic open/close/locking main clamps. Hydraulic in/out facing tool and heating plate.

Main frame includes 4 light weight alloy main clamps of 1200mm/48" diameter.

IPS machine includes two-piece clamps (4 circles), including 48"x42", 42"x40", 40"x36", 36"x32", 32"x28", 28"x24".

Metric machine includes clamps (4 circles), including 1200x1000, 1200x900, 1200x800, 800x710, 800x630mm

Aluminium PTFE coated heating plate and electrically operated facing tool is hydraulically inserted and removed during welding operation.

Stand for heating plate and facing tool assembly is attached to the rear of the main frame after shipping, and removed again at the end of the job

Electrohydraulic pump with controls, accumulator and quick release hoses. Includes countdown timers for heating and cooling phases.

Genuine 2 year international warranty.

Optional steel stub device for welding end fittings.

Wired ready to accept Worldpoly or other data logger.

Tool box including tools, bolts etc.

Optional wheeled trolley and on-board diesel generator available.

400 volt 3 phase 50/60 Hz (30.6 kw, 47.6 A).

Minimum generator required: 400 volt 3 phase 50 hz, 32 KVA. Provide full machine details to generator supplier before purchase.

Weight 5000 kg.

Total cylinder area: 56 cm², maximum pump pressure 180 bar. Optional 120 cm² x 200 bar.

Please note technical specifications of Worldpoly machines may change without notice



Worldpoly1600

Worldpoly1600 hydraulically operated butt-welding machine suitable for PE and PP pipes and fittings from 1000 to 1600mm, or alternatively 42" to 60" OD. Available to weld according to ISO/DVS/POP003 SLP & DLP low pressure, and optionally both low and high-pressure according to ISO, POP003 and North American Standards. Excellent design and construction provide a premium machine for welding both on the worksite and in the factory. Welding can be carried out between clamps 3 & 4 for tees, bends and manifold work. All hydraulics and controls are located on the main welding frame. Can be integrated with optional data logger.

TECHNICAL SPECIFICATIONS

Standard welding range 1600mm SDR 17 to 1000mm SDR 11.

CE approved by SGS www.sgs.com

Genuine 2 year international warranty.

Main frame includes 4 steel main clamps of 1600mm diameter. Heating plate is automatically separated from the pipe at the end of the heating cycle.

Layer clamps: 1600x1400, 1400x1200, 1200x1000.

Electrohydraulic pump with controls and accumulator are mounted on the main frame. Includes countdown timers for heating and cooling phases.

Removable steel electric facing tool with current overload protection.

Aluminium PTFE coated heating plate with electronic temperature control. Heating plate automatically releases from pipe ends after heating.

Stand for heating plate and facing tool.

Wired ready to accept Worldpoly or other data logger.

Tool box including tools, bolts etc.

400 volt 3 phase 50/60 Hz (54 kw 86 A) alt 440 volt 3 phase 60 hz (63 kw 100 A).

Minimum generator 400 volt 60 KVA. Check with your generator supplier for suitability.

Total cylinder section: optional 68.7 cm² or 95.4 cm²

Please note technical specifications of Worldpoly machines may change without notice



Worldpoly1600 Hydra HF

Worldpoly1600 Hydra HF hydraulically operated butt-welding machine suitable for PE and PP pipes and fittings from 1000 to 1600mm, or alternatively 42" to 60" OD. Available to weld according to ISO 4427-2 SHP, POP003 SHP and North American Standards. Excellent design and construction provide a premium machine for welding both on the worksite and in the factory. Hydraulic open/close/locking of main clamps. Welding can be carried out between clamps 3 & 4 for tees, bends and manifold work. Can be integrated with optional data logger.

TECHNICAL SPECIFICATIONS

Standard welding range 1600mm SDR 17 to 1000mm SDR 11.

CE approved by SGS www.sgs.com

Genuine 2 year international warranty.

Main frame includes 4 steel main clamps of 1600mm diameter. Heating plate is automatically separated from the pipe at the end of the heating cycle.

Layer clamps: 1600mmx1400mm, 1400mmx1200mm, 1200mmx1000mm

Removable steel electric facing tool with current overload protection.

Aluminium PTFE coated heating plate with electronic temperature control. Heating plate automatically releases from pipe ends after heating.

Stand for heating plate and facing tool.

Wired ready to accept Worldpoly or other data logger.

Tool box including tools, bolts etc.

400 volt 3 phase 50/60 Hz (54 kw 86 A) alt 440 volt 3 phase 60 hz (63 kw 100 A).

Minimum generator 400 volt 60 KVA. Check with your generator supplier for suitability.

Total cylinder section mm².

Please note technical specifications of Worldpoly machines may change without notice



Worldpoly2000

Worldpoly2000/80 hydraulically operated butt-welding machine suitable for PE and PP pipes and fittings from 1400mm to 2000mm or alternatively 64" to 76" OD. Available to weld according to ASTM, ISO/DVS/POP003 SLP & DLP low pressure, and optionally both low and high-pressure according to ISO, POP003 and North American Standards. Hydraulic locking of main clamps. Excellent design and construction provide a premium machine for welding both on the worksite and in the factory. Welding can be carried out between clamps 3 & 4 for tees, bends and manifold work. All hydraulics and controls are located on the main welding frame. Can be integrated with optional data logger.

TECHNICAL SPECIFICATIONS

Genuine 2 year international warranty.

Welding range 2000mm to 1400mm, alternatively 80" IPS (2032mm OD) to 54" (1371.6 mm OD), SDR 33 to SDR 17

Removable cast Aluminium electric facing tool with current overload protection.

Removable cast Aluminium PTFE coated heating plate with electronic temperature control.

Stand for heating plate and facing tool.

On-board electrohydraulic pump with controls, accumulator and quick release hoses. Includes countdown timers for heating and cooling phases.

400 volt 3 phase 50/60 Hz, 88 KW 125 Amps.

Cylinder section 107.54 cm², 10,754 mm².

Please note technical specifications of Worldpoly machines may change without notice



Worldpoly2400

Worldpoly2400/88" hydraulically operated butt-welding machine suitable for PE and PP pipes and fittings to 2400mm OD, or alternatively 54" to 88" OD. Available to weld according to ISO/DVS/POP003 SLP & DLP low pressure, and optionally both low and high-pressure according to ISO, POP003 and North American Standards. Excellent design and construction provide a premium machine for welding both on the worksite and in the factory. Welding can be carried out between clamps 3 & 4 for tees, bends and manifold work. Can be integrated with optional data logger.



TECHNICAL SPECIFICATIONS

Genuine 2 year international warranty.

Welding range to 2400mm, alternatively 88" IPS, SDR 17

Removable cast Aluminium electric facing tool with current overload protection.

Removable cast Aluminium PTFE coated heating plate with electronic temperature control.

Stand for heating plate and facing tool. Optional trolley base.

On-board electrohydraulic pump with controls, accumulator and quick release hoses. Includes countdown timers for heating and cooling phases.

Optional trolley base.

400 volt 3 phase 50/60 Hz

Please note technical specifications of Worldpoly machines may change without notice. Please confirm at time of order.



Trolleys

Worldpoly supplies purpose built trolleys to carry the entire machine including main frame, facing tool, heating plate and hydraulic unit, or for the main frame only. Please contact our Sales Department on sales@worldpoly.com, or +61 (0)3 8795 3888 for details.



TECHNICAL SPECIFICATIONS

Trolleys are available to carry all parts of the welding machine including main frame, hydraulic unit, facing tool and heating plate.

Worldpoly has a standard range of trolley designs including in-line and lateral mounting of the main frame.

We also offer to produce trolleys to your specific requirements.



PolyBasic6"

A manually operated butt-welding machine suitable for PE and PP pipes and fittings from 2" - 6" OD. Efficient design and construction provides an excellent low cost machine for welding both on the worksite and in the factory. The use of high quality aluminium castings allows for lower weight without compromising strength and performance. Optional torque wrench allows welding force to be read.



TECHNICAL SPECIFICATIONS

Welding range 2" - 6": DR 11 (160 psi) to DR 41 (PN4)

Complete and ready to weld

Genuine 12 months international warranty

Main frame includes light weight alloy main clamps of 160mm diameter.

IPS inch layer clamps 2", 3" & 4"

Removable cast aluminium PTFE coated heating plate with electronic temperature control

Removable cast aluminium electrically operated facing tool

Stand for heating plate and facing tool

Manual opening of frame. Optional torque wrench for measurement of welding force

230 volt 50/60 Hz (2.2 kw 11.1 A)

Requires generator minimum 2.3 KVA

Weight 77kg

Please note technical specifications of Worldpoly machines may change without notice



Worldpoly 3" High Pressure

High and low-pressure butt fusion. Worldpoly 2/8 High Pressure is a hydraulically operated butt-welding machine suitable for PE and PP pipes and fittings from 2" to 8" IPS, using both high and low pressure welding methods. Excellent Australian Engineered design and construction provides a premium machine for welding both on the worksite and in the factory. The use of high quality construction allows for lower weight without compromising strength and performance, while providing extra strength when welding out-of-round pipe. Significantly increased force is available for drag when welding pipe strings, or on difficult sites. Welding can be carried out between clamps 3 & 4 for tees, bends and manifold work, and the machine is pre-wired for immediate integration with optional data logger.

TECHNICAL SPECIFICATIONS

Welding range 2" to 8" IPS: DR 9 (PN20) to DR 41 (PN4) according to ASTM, CSA and ISO 21307 specifications

Complete and ready to weld - Genuine 2 year warranty on parts - CE approved by SGS www.sgs.com

Included as standard (unless otherwise specified):

- Main frame, including 4 light weight pressure-cast alloy main clamps of 160mm diameter
- Removable cast Aluminium electric facing tool with current overload protection
- Electrohydraulic pump with controls, and quick release hoses. Includes countdown timers for heating and cooling phases
- PTFE coated heating plate with electronic temperature control (heating plate automatically separates from pipe ends after heating)
- Stand for heating plate and facing tool
- Tool box including tools, bolts, selected spare parts, etc
- German hydraulic seals
- Wired ready to accept Worldpoly or other data logger

Clamp options include (machine can be supplied with any combination of liner diameters):

- Layer clamps: 8" x 6", 6" x 4", 4" x 3", 3" x 2 1/2", 2 1/2" x 2"
- Narrow clamps: 8" x 6", 8" x 4", 8" x 3", 8" x 2"

Optional stub end device for welding end fittings (available in aluminium or steel)

Optional wheeled trolley available

220 volt 1 ph. 50/60 Hz (3.0 kw 16A)

Requires generator minimum 220 volt 3.5 KVA - provide full machine details to generator supplier before purchase

Total cylinder section 0.970"2 (6.26 cm2), maximum pump pressure 2610 psi (180 bar)

Weight 344 lb (156kg)

Please note technical specifications of Worldpoly machines may change without notice



Worldpoly 10" High Pressure

High and low-pressure butt fusion. Worldpoly 3/10 High Pressure is a hydraulically operated butt-welding machine suitable for PE and PP pipes and fittings from 3" to 10" IPS, using both high and low pressure welding methods. Excellent Australian Engineered design and construction provides a premium machine for welding both on the worksite and in the factory. The use of high quality construction allows for lower weight without compromising strength and performance, while providing extra strength when welding out-of-round pipe. Significantly increased force is available for drag when welding pipe strings, or on difficult sites. Welding can be carried out between clamps 3 & 4 for tees, bends and manifold work, and the machine is pre-wired for immediate integration with optional data logger.

TECHNICAL SPECIFICATIONS

Welding range 3" to 10" IPS SDR 9 (PN20) to SDR 17. 3" to 6" SDR 9 and 11 only

Welds both high and low pressure according to ASTM, CSA and ISO

Complete and ready to weld pipe and fittings diameters 10", 8", 6", 4" and 3" to IPS

Genuine 24 month international warranty.

Electro-hydraulic pump with controls, and quick release hoses.

Removable cast Aluminum PTFE coated heater plate with electronic temperature control. Heating plate automatically separates from pipe ends after heating.

Electrically operated facing tool for correct preparation of pipe ends.

Stand for heating plate and facing tool.

Tool box including tools, bolts etc.

Easily welds between clamps 3 and 4 for tees, fabrications and tight welds. Low pressure welding only when using single clamp.

Wired ready to accept Worldpoly or other data logger.

230 volt, single phase, 50/60 hz. 6.2 kw, 19.8 A. Uses 2 x 15 A input leads.

Minimum generator required: 230 volt - 7 KVA. Provide full machine details to generator supplier before purchase.

Weight 355kg / 781 lb.

Specifications are subject to change without notice. Please confirm at time of purchase.



Worldpoly 16" High Pressure

High pressure welding. Worldpoly 8/16 High Pressure is a hydraulically operated butt-welding machine suitable for PE and PP pipes and fittings from 8" to 16" IPS, using both high and low pressure welding methods. Excellent Australian Engineered design and construction provides a premium machine for welding both on the worksite and in the factory. The use of high quality pressure-cast Aluminium clamps allows for lower weight without compromising strength and performance, while providing extra strength when welding out-of-round pipe. Significantly increased force is available for drag when welding pipe strings, or on difficult sites. Welding can be carried out between clamps 3 & 4 for tees, bends and manifold work, and the machine is pre-wired for immediate integration with optional data logger, and overhead electric crane.

TECHNICAL SPECIFICATIONS

Welding range 8" to 16" IPS SDR 9 (PN20) to SDR 17. 8" and 10" SDR 9 and 11 only.

Welds high pressure according to ASTM and CSA and ISO.

Complete and ready to weld pipe and fittings diameters 16", 14", 12", 10" & 8" IPS

Genuine 24 month international warranty.

Electro-hydraulic pump with controls, and quick release hoses.

Removable cast Aluminum PTFE coated heating plate with electronic temperature control. Heating plate automatically separates from pipe ends after heating.

Electrically operated facing tool for correct preparation of pipe ends.

Stand for heating plate and facing tool.

Tool box including tools, bolts etc.

Optional overhead electric crane.

Total cylinder area: 22.36 cm² / 2236 mm²

Weight 776 kg / 1,707 lb (including crane and stub device)

400V 3 phase 50/60 Hz (10.5 kw 18.4 A).

Specifications are subject to change without notice. Please confirm at time of purchase.



Rentals

Worldpoly certified field welding machines are normally available for rent in a number of countries and regions including Australia, South East Asia, Europe, Latin America, South Africa and UAE. Please contact rental@worldpoly.com for details of your local rental outlet.

TECHNICAL SPECIFICATIONS

Worldpoly field welding machines are normally available for rental in the following countries:

Australia/South East Asia - 63mm to 1200mm

Germany/Europe - 90mm to 1200mm

Chile/Latin America - 63mm to 450mm

UAE - 63mm to 315mm

As availability is subject to prior rental, please contact us for details at rental@worldpoly.com.

FABRICATION MACHINES



Workshop equipment for the production of manifolds, fabrications, pipe spools, bends, tees, crosses, branch fittings, wyes, reduced outlet tees and general fabrications.

- **WORKSHOP WELDING MACHINES**
- **WORKSHOP PIPE SAWS**
- **SADDLE FUSION MACHINES**



PolyWorkshop315/90

Hydraulically operated workshop machine for the butt-welding of pipes and fittings in PE, PP and other thermoplastic materials. Pivoting clamps allow for the fabrication of segmented bends of different radii. Optional clamps allow the production of bends from 90 to 315mm OD, 90 to 315mm 90 degree equal tees and crosses, and 45 and 60 degree branch tees 90mm to 315mm. Includes pressure transducer and wiring ready to immediately accept optional data logger.

TECHNICAL SPECIFICATIONS

CE approved by SGS www.sgs.com

Genuine 2 year international warranty.

German hydraulic seals.

Welding range: 90 to 315mm SDR 9 (PN20) to SDR 41 (PN4).

Segmented bends range 90, 110, 125, 140, 160, 180, 200, 225, 250, 280 & 315mm.

90 degree equal tees and crosses range 90, 110, 125, 140, 160, 180, 200, 225, 250, 280 & 315mm.

Optional clamps for 45 and 60 degree branch tees 90, 110, 125, 140, 160, 180, 200, 225, 250, 280 & 315mm.

Optional narrow fittings clamp & stub device

230 volt 1 phase 50 Hz (7.3 kw 36 A) alt. 380 volt 3 phase 50 Hz (7.3 kw 12 A) alt. 400 volt 3 phase 50 Hz (8.3 kw 13.4 A). Optional 60 Hz also available.

Cylinder area 12.56cm²

Please note technical specifications of Worldpoly machines may change without notice



PolyWorkshop450/160

Hydraulically operated workshop machine for the butt-welding of pipes and fittings in PE, PP and other thermoplastic materials. Pivoting clamps allow for the fabrication of segmented bends of different radii. Optional clamps allow the production of bends from 160 to 450mm OD and 160 to 450mm 90 degree equal tees and crosses. Note - Please refer to the PolyWorkshop450-Y if 45 & 60 degree branch clamps will need to be produced.

TECHNICAL SPECIFICATIONS

CE approved by SGS www.sgs.com

Welding range 160mm to 450mm SDR 9 (PN20) to SDR 41 (PN4).

Bend clamps produce segmented bends range: 160, 180, 200, 225, 250, 280, 315, 355, 400 & 450mm.

Tee and cross clamps produce 90 degree equal tees and crosses range: 160, 180, 200, 225, 250, 280, 315, 355, 400 & 450mm.

400 volt 3 phase 50 Hz (18.9 kw 32.6 A). Optional 60 Hz also available.

Genuine 2 year warranty

German hydraulic seals.

Cylinder area 12.56cm²

Please refer to the PolyWorkshop450-Y if 45 & 60 degree branch clamps will need to be produced

Technical specifications of Worldpoly machines may change without notice



Polyworkshop450-Y

Hydraulically operated workshop machine for the butt-welding of pipes and fittings in PE & PP. Pivoting clamps allow for the fabrication of segmented bends of different radii. Included as standard with this machine are all clamps required for the production of bends from 160mm to 450mm OD / alternatively 8" to 18" IPS. Optional clamps allow production of 90 degree equal tees and crosses 160mm to 450mm, and 45 and 60 degree branch tees 160mm to 450mm. CNC touch-screen control of welding operations and integral data logger are standard.

TECHNICAL SPECIFICATIONS

CE approved by SGS www.sgs.com

Welding range 160mm to 450mm SDR 9 (PN20) to SDR 41 (PN4)

Bend clamps produce segmented bends range: 160, 180, 200, 225, 250, 280, 315, 355, 400 & 450mm

Tee and cross clamps produce 90 degree equal tees and crosses range: 160, 180, 200, 225, 250, 280, 315, 355, 400 & 450mm.

Wye/branch clamps produce true-Y, 45 and 60 degree branch tees in the range of: 160, 180, 200, 225, 250, 280, 315, 355, 400 & 450mm

CNC touch-screen control of welding operations and integral data logger are standard

400 volt 3 phase 50 Hz (31.4 kw 49.4 A). Optional 60 Hz also available

Genuine 2 year warranty

Weight 2,850 kg

Cylinder area 12.56cm²



PolyWorkshop630/315CNC

Hydraulically operated workshop machine for the butt-welding of pipes and fittings in PE, PP and other thermoplastic materials. Pivoting clamps allow for the fabrication of segmented bends of different radii. Optional clamps allow the production of bends from 315 to 630mm OD, 315 to 630mm 90 degree equal tees and crosses, and 45 and 60 degree branch tees 315mm to 630mm. Touch-screen with CNC control of welding cycle and 5000 weld data logging is standard. German seals.

TECHNICAL SPECIFICATIONS

CE approved by SGS www.sgs.com

Welding range 315 to 630mm SDR 9 to SDR 41, CNC operation with touch-screen and integrated 5000 weld data logger is standard

Bend clamps allow production of segmented bends diameter 315, 355, 400, 450, 500, 560 & 630mm OD.

Tee clamps produce 90 degree equal tees and crosses diameter 315, 355, 400, 450, 500, 560 and 630mm OD.

Wye / branch tee clamps produce true-Y, 45 and 60 degree equal Y-branch tees 315, 355, 400, 450, 500, 560 and 630mm OD.

Hydraulic open/close and locking of main bend clamps. Optional for Tee clamps. Basic model is available without this feature.

400 volt 3 phase 50 Hz (32.7 kw 52.6 A). Optional 60 Hz also available.

Genuine 2 year international warranty.

Total cylinder area 19.63cm²

Please note technical specifications of Worldpoly machines may change without notice



PolyWorkshop24/12 CNC

Hydraulically operated workshop machine for the butt-welding of pipes and fittings in PE, PP and other thermoplastic materials. Pivoting clamps allow for the fabrication of segmented bends of different radii. Optional clamps allow the production of bends from 12" to 24" OD, 12" to 24" 90 degree equal tees and crosses, and 45 and 60 degree branch tees 12" to 24". Includes pressure transducer and wiring ready to immediately accept optional data logger. Touch-screen with CNC control of welding cycle and 5000 weld data logging is standard.

TECHNICAL SPECIFICATIONS

Welding range 12" to 24" IPS SDR 9 to SDR 41

Bend clamps allow production of segmented bends diameter 12", 14", 16", 18", 20", 22" & 24" IPS

Tee clamps produce equal tees and crosses diameter 12", 14", 16", 18", 20", 22" & 24" IPS

Wye / branch tee clamps produce true-wyes, 45 & 60 degree branch tees diameter 12", 14", 16", 18", 20", 22" & 24"

Hydraulic open/close and locking of bend clamps

CNC operation with touch-screen and integrated 5000 weld data logger is standard

Please note technical specifications of Worldpoly machines may change without notice



PolyWorkshop800/450

Hydraulically operated workshop machine for the butt-welding of pipes and fittings in PE, PP and other thermoplastic materials. Pivoting clamps allow for the fabrication of segmented bends of different radii. Included as standard with this machine are all clamps required for the production of bends from 450mm to 800mm OD. Optional clamps allow production of 90 degree equal tees and crosses 450mm to 800mm, and 45 and 60 degree branch tees 450mm to 800mm. Immediately accepts optional data logger. CNC touch-screen control of welding cycle is standard.

TECHNICAL SPECIFICATIONS

CE approved by SGS www.sgs.com

Welding range 450 to 800 mm SDR 11 to DR 41.

Bend clamps allow production of segmented bends diameter 450, 500, 560, 630, 710 and 800mm OD.

Tee clamps produce 90 degree equal tees and crosses 450, 500, 560, 630, 710 and 800mm OD.

Wye / branch tee clamps produce true-Y, 45 and 60 degree equal Y-branch tees 450, 500, 560, 630, 710 and 800mm OD.

CNC touch-screen control of welding operations and integral data logger are standard.

German hydraulic seals.

400 volt 3 phase 50 Hz (50.9 kw 79 A). Optional 60 Hz also available.

Genuine 2 year warranty on parts

Total cylinder area: 31.17cm²

Please note technical specifications of Worldpoly machines may change without notice



PolyWorkshop800/355

Hydraulically operated workshop machine for the butt-welding of pipes and fittings in PE, PP and other thermoplastic materials. Pivoting clamps allow for the fabrication of segmented bends of different radii. Optional clamps allow the production of bends from 355 to 800mm OD, 355 to 800mm 90 degree equal tees and crosses, and 45 and 60 degree branch tees 355mm to 800mm. Includes pressure transducer and wiring ready to immediately accept optional data logger. CNC touch-screen control and integral data logger are standard.

TECHNICAL SPECIFICATIONS

Genuine 2 year international warranty.

Welding range 355 to 800mm: SDR 9 (PN20) to SDR 41 (PN4).

Bend clamps produce segmented bends range 355, 400, 450, 500, 560, 630, 710 & 800mm OD.

Tee and cross clamps produce 90 degree equal tees and crosses range 355, 400, 450, 500, 560, 630, 710 & 800mm OD.

Wye / branch tee clamps produce 45 and 60 degree branch tees range 355, 400, 450, 500, 560, 630, 710 and 800mm OD.

400 volt 3 phase 50 Hz (50.9 kw 79 A). Optional 60 Hz also available.

German hydraulic seals.

Total cylinder area: 31.17cm²



PolyWorkshop1000/500

Hydraulically operated workshop machine for the butt-welding of pipes and fittings in PE, PP and other thermoplastic materials. Pivoting clamps allow for the fabrication of segmented bends of different radii. Optional clamps allow the production of bends from 500 to 1000mm OD, 500 to 1000mm 90 degree equal tees and crosses, and 45 and 60 degree branch tees 500mm to 1000mm. Includes pressure transducer and wiring ready to immediately accept optional data logger. CNC touch-screen control of welding operation and integral data logger are standard.

TECHNICAL SPECIFICATIONS

Welding range 500 to 1000mm SDR 11 to SDR 41.

CNC touch-screen control of welding operations and integral data logger are standard.

Bend clamps allow production of segmented bends in diameters 500, 560, 630, 710, 800, 900 and 1000mm OD.

Tee and cross clamps produce 90 degree equal tees and crosses in diameters 500, 560, 630, 710, 800, 900 and 1000mm OD.

Optional wye / branch tee clamps produce true-Y, 45 and 60 degree equal Y-branch tees 500, 560, 630, 710, 800, 900 and 1000mm OD.

Manual open-close and locking of main bend clamps.

German hydraulic seals.

400 volt 3 phase 50 Hz (82.7 kw 130 A). Optional 60 Hz also available.

2 year international warranty.

Total cylinder area: 38.46cm²

Please note technical specifications of Worldpoly machines may change without notice



PolyWorkshop1200/630

Hydraulically operated workshop machine for the butt-welding of pipes and fittings in PE, PP and other thermoplastic materials. Pivoting clamps allow for the fabrication of segmented bends of different radii. Optional clamps allow the production of bends from 630 to 1200mm OD, 630 to 1200mm 90 degree equal tees and crosses, and 45 and 60 degree branch tees 630mm to 1200mm. Includes pressure transducer and wiring ready to immediately accept optional data logger. CNC touch-screen control of welding operations and integral data logger are standard.

TECHNICAL SPECIFICATIONS

CE approved by SGS www.sgs.com

Welding range 630 to 1100mm SDR 11 to SDR 41, 1200mm SDR 17.

Bend clamps allow production of segmented bends in diameters 630, 710, 800, 900, 1000 and 1200mm OD.

Tee and cross clamps produce 90 degree equal tees and crosses in diameters 630, 710, 800, 900, 1000 and 1200mm OD.

Wye / branch tee clamps produce true-Y, 45 and 60 degree equal Y-branch tees 630, 710, 800, 900, 1000 and 1200mm OD.

Hydraulic open-close and locking of main bend clamps. Basic machine is available without this option if requested.

400 volt 3 phase 50 Hz (82.7 kw 130 A). Optional 60 Hz also available.

Genuine 2 year international warranty.

Total cylinder area: 38.46cm²

Please note technical specifications of Worldpoly machines may change without notice



PolyWorkshop1600/1000

Hydraulically operated workshop machine for the butt welding of pipes and fittings in PE, PP and other thermoplastic materials. Pivoting clamps allow for the fabrication of segmented bends of different radii. Capacity 1000 to 1600mm OD bends, 1000 to 1600mm equal tees and crosses, and 1000 to 1600mm 45 and 60 degree equal branch tees. PLC controlled including 5,000 weld data logging.

TECHNICAL SPECIFICATIONS

Welding Range: 1000-1600mm SDR41-SDR17, 1200-1000mm SDR 11-SDR 41, for all diameters of elbow, tee, cross clamps and Y clamps

PLC controlled including 5,000 weld data logging

Elbow clamps permit production of segmented bends diameter 1600, 1400, 1200 and 1000mm OD

Tee and cross clamps allow production of equal tees and crosses diameter 1600, 1400, 1200 and 1000mm OD

Y-branch clamps produce 45 and 60 degree equal branch tees and true-wyes diameter 1600, 1400, 1200 and 1000mm OD.

Hydraulic open-close and locking of main bend clamps, and one side of tee and branch-tee clamps.

German hydraulic seals.

Specifications are subject to change without notice. Please confirm with Worldpoly prior to order confirmation.



PolyWorkshop2000/1400

Hydraulically operated workshop machine for the butt welding of pipes and fittings in PE, PP and other thermoplastic materials. Pivoting clamps allow for the fabrication of segmented bends of different radii. Capacity 1400 to 2000mm OD bends, 1400 to 2000mm equal tees and crosses, and 1400 to 2000mm 45 and 60 degree equal wye-branch tees. Includes pressure transducer and wiring ready to immediately accept optional data logger.

TECHNICAL SPECIFICATIONS

Welding Range: 2000mm - 1400mm. 2000 & 1800mm maximum SDR 17. 1600 & 1400mm maximum SDR 13.6 for all diameters of elbow, tee, cross clamps and Y clamps

Genuine 2 year international warranty provided by Worldpoly Australia

PLC touch-screen controlled, includes 5,000 weld data logging

Produces bends 2000, 1800, 1600 & 1400mm OD

Produced equal tees 2000, 1800, 1600 & 1400mm OD

Produces equal crosses 2000, 1800, 1600 & 1400mm OD

When optional clamps are selected, produces 45 and 60 degree Wye-branch tees 2000, 1800, 1600 & 1400mm OD

Hydraulic open-close and locking of main bend clamps

German hydraulic seals

400 volt 3 phase 50 Hz . Optional 60 Hz also available

Please note technical specifications of Worldpoly machines may change without notice

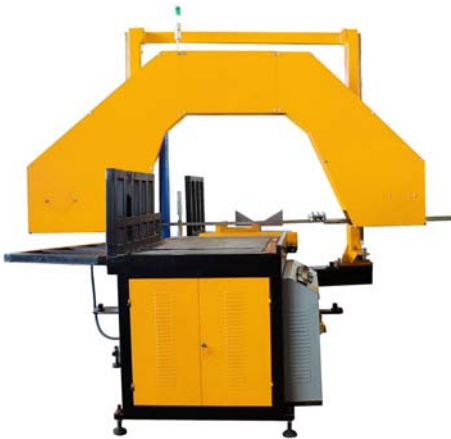

PolySaw315/12

Hydraulically operated pipe saw specifically produced for the preparation of pipe segments in PE, PP and other thermoplastic materials, used for the production of bends, tees and other fabrications.

Capacity 90 to 315mm OD / 3" to 12" IPS. Cutting angle is up to 67 degrees.

Lowering rate of saw is hydraulically controlled, as are the strap clamps used to hold pipe segments in place. Saw blade made in Germany.

TECHNICAL SPECIFICATIONS

CE approved by SGS www.sgs.com

Cutting range 90 to 315mm OD.

67 degree maximum cutting angle allows production of segments for bends, tees and Y-branch tees.

Angular cutting error equal to or less than 1 degree.

Speed of saw blade 195 m/min.

Genuine 24 months international warranty.

400 volt 3 phase 50hz (3 kw 6.4 A)

Weight 1,900kg

Please note technical specifications of Worldpoly machines may change without notice



PolySaw630/24

Hydraulically operated pipe saw specifically produced for the preparation of pipe segments in PE, PP and other thermoplastic materials, used for the production of bends, tees and other fabrications.

Capacity 90 to 630mm OD / 3" to 24" IPS. Cutting angle is up to 67 degrees.

Lowering rate of saw is hydraulically controlled as are the strap clamps used to hold pipe segments in place. Saw blade made in Germany.

TECHNICAL SPECIFICATIONS

CE approved by SGS www.sgs.com

Cutting range 90 to 630mm OD.

67 degree maximum cutting angle allows production of segments for bends, tees and Y-branch tees.

Angular cutting error equal to or less than 1 degree.

Speed of saw blade 195 m/min.

Genuine 12 month international warranty.

400 volt 3 phase 50 Hz (3.7 kw 8.3 A)

Weight 3,980kg

Please note technical specifications of Worldpoly machines may change without notice



PolySaw800/32

Hydraulically operated pipe saw specifically produced for the preparation of pipe segments in PE, PP and other thermoplastic materials, used for the production of bends, tees and other fabrications.

Capacity 90 to 800mm OD / 3" to 32" IPS. Cutting angle is up to 67 degrees.

Lowering rate of saw is hydraulically controlled, as are the strap clamps used to hold pipe segments in place. Saw blade made in the Germany.

TECHNICAL SPECIFICATIONS

CE approved by SGS www.sgs.com

Genuine 2 year international warranty

Cutting range 90 to 800mm OD / 3" to 32" IPS

67 degree maximum cutting angle allows production of segments for bends, tees and Y-branch tees from 90 to 800mm OD / 3" to 32" IPS

Angular cutting error equal to or less than 1 degree

Speed of saw blade 195 m/min

400 volt 3 phase 50 Hz (3.7 kw 8.3 A) alt. 460 volt 3 phase 60 Hz

Weight 4,500kg

Please note technical specifications of Worldpoly machines may change without notice



PolySaw1200/48

Hydraulically operated pipe saw specifically produced for the preparation of pipe segments in PE, PP and other thermoplastic materials, used for the production of bends, tees and other fabrications.

Capacity 630 to 1200mm OD / 24" to 48" IPS. Cutting angle is up to 67 degrees.

Lowering rate of saw is hydraulically controlled, as are the top-mounted V-clamps used to hold pipe segments in place.

Saw blade made in Germany.

TECHNICAL SPECIFICATIONS

CE approved by SGS www.sgs.com

Cutting range 630 to 1200mm OD

67 degree maximum cutting angle allows production of segments for bends, tees and Y-branch tees

Cutting feed is hydraulically controlled

Infrared positioning.

Special saw blade available for thick walled pipe

Angular cutting error equal to or less than 1 degree

Genuine 2 year international warranty

Speed of saw blade 250 m/min

400 volt 3 phase 50 Hz (5.5 Kw 4.2 A)

Weight 7,000kg

Please note technical specifications of Worldpoly machines may change without notice



PolySaw1600/65

A hydraulically operated pipe saw specifically produced for the preparation of pipe segments in PE, PP and other thermoplastic materials, used for the production of bends, tees and other fabrications.

Capacity 630 to 1600mm OD / 24" to 65" IPS. Cutting angle is up to 67 degrees.

Lowering rate of saw is hydraulically controlled, as are the top-mounted V-clamps used to hold pipe segments in place.

Saw blade made in Germany.

TECHNICAL SPECIFICATIONS

CE approved by SGS www.sgs.com

Cutting range 630 to 1600mm OD.

67 degree maximum cutting angle allows production of segments for bends, tees and Y-branch tees.

Cutting feed is hydraulically controlled.

Infrared positioning.

Special saw blade available for thick walled pipe.

Angular cutting error equal to or less than 1 degree.

Genuine 2 year international warranty.

Speed of saw blade 250 m/min.

400 volt 3 phase 50 Hz (5.5 kw 13.4 A)

Weight 9,000kg

Please note technical specifications of Worldpoly machines may change without notice



PolySaw1710/68

Hydraulically operated pipe saw specifically produced for the preparation of pipe segments in PE, PP and other thermoplastic materials, used for the production of bends, tees and other fabrications.

Capacity 630/24" to 1710mm/68". Cutting angle is up to 67 degrees.

Lowering rate of saw is hydraulically controlled, as are the top-mounted V-clamps used to hold pipe segments in place.

Saw blade made in Germany.

TECHNICAL SPECIFICATIONS

CE approved by SGS www.sgs.com

Cutting range 20" to 68" nom. - 630 to 1710mm OD.

Angular cutting error equal to or less than 1 degree.

Speed of saw blade 250 m/min.

400 volt 3 phase 50 Hz (5.5 kw 13.4 A) alt. 220 volt 3 phase 60 Hz

Weight 9,000kg

Please note technical specifications of Worldpoly machines may change without notice



PolySaw2000/78

Hydraulically operated pipe saw specifically produced for the preparation of pipe segments in PE, PP and other thermoplastic materials, used for the production of bends, tees and other fabrications.

Capacity 1200 to 2000mm / 48 to 78". Cutting angle up to 67 degrees.

Lowering rate of saw is hydraulically controlled, as are the top-mounted V-clamps used to hold pipe segments in place.

Saw blade made in Germany.

TECHNICAL SPECIFICATIONS

Cutting range 1200 to 2000mm OD / 48 to 78"

Capacity 2000mm & 1800mm maximum SDR 17. 1600mm, 1400mm & 1200mm maximum SDR 13.6

67 degree maximum cutting angle allows production of segments for bends, tees and Y-branch tees.

Angular cutting error equal to or less than 1 degree.

Genuine 24 month international warranty.

400 volt 3 phase 50 Hz (3.7 kw 8.3 A)

Please note technical specifications of Worldpoly machines may change without notice



PolySaddleSaw500

Purpose built bandsaw for cutting the radius required when welding reducing tees using WHM630, WHM1000 or WHM1200 saddle fusion machine, or when hand fabricating pipe manifolds.

Cuts pipe segment end to the correct radius.

TECHNICAL SPECIFICATIONS

CE approved by SGS www.sgs.com

Radius saw is used to cut branch pipes used in production of reducing tees and manifolds.

Cuts pipe diameters 63, 90, 110, 125, 140, 160, 200, 225, 250, 280, 315, 355, 400, 450 & 500mm.

Also available in smaller models with capacity 400mm and 315mm at lower cost.

Electrically operated.

Swedish steel blade.

Manual feeding speed.

400 volt 3 phase 50 Hz (2.2 kw 4.2 A) alt. 60 Hz US voltage available.

FITTINGS DIAGRAMS

Equal Branch Tee and Wye

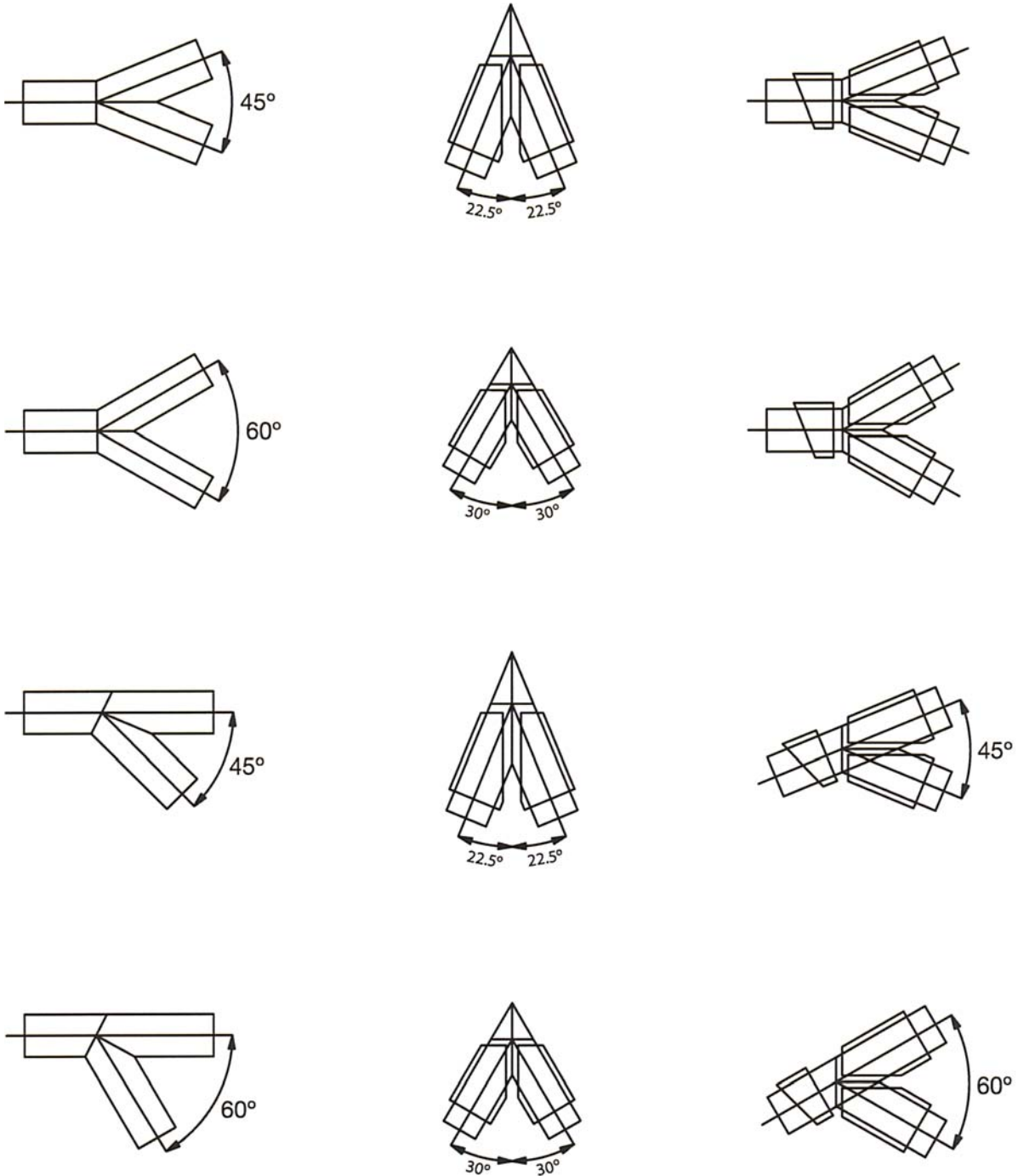



PolySaddle630/315

Hydraulically operated saddle fusion machine for the production of 90-degree reducing tees from standard PE pipe sections. Capacity 315 to 630mm OD main pipe, 63 to 315mm branch pipe. Machine is constructed to allow operation by one person, incorporating main pipe clamp, branch pipe clamps, hydraulically removed heating plate with curved elements and integrated hole saw for final removal of pipe coupon.

TECHNICAL SPECIFICATIONS

CE approved by SGS www.sgs.com

Genuine 12 month international warranty.

Main pipe range 315, 355, 400, 450, 500, 560 & 630mm.

90 degree branch pipe range 63, 90, 110, 160, 180, 200, 225, 250, 280, 315mm.

Heating saddles and hole saws required for each main / outlet combination.

Hydraulically removed heating plate with Teflon coated radius attachments.

Hydraulic loading system for main pipe.

Count-down timer for heating and cooling times (to be set by operator).

Control panel with electro-hydraulic controls.

400 volt 3 phase 50 Hz (11.3 kw 18 A). Optional 60 Hz US voltage also available.

Cylinder area: 12.56cm²

Note: When producing saddle fusion reducing tees, outlet diameter should be no greater than 50% of main diameter.

Video: http://www.youtube.com/watch?v=dOta_oucBJg

Specifications are subject to change without notice. Please reconfirm at time of order placement.



PolySaddle1200/500 (48"/20")

Hydraulically operated saddle fusion machine for the production of 90-degree reducing tees from standard PE pipe sections. Capacity 280 to 1200mm / 10" to 48" main pipe, 63 to 500mm / 2" to 20" branch pipe. Machine is constructed to allow operation by one person, incorporating main pipe clamp, branch pipe clamps, hydraulically removed heating plate with curved elements and integrated hole saw for final removal of pipe coupon.

TECHNICAL SPECIFICATIONS

CE approved by SGS www.sgs.com

Genuine 24 month international warranty.

Main pipe range 315, 355, 400, 450, 500, 560, 630, 710, 800, 900, 1000 and 1200mm / 12, 14, 16, 18, 20, 22, 24, 26, 28, 32, 36, 40 & 48".
Optionally can be supplied to weld down to 315 and 355mm OD main pipe.

90 degree branch pipe range 63, 90, 110, 160, 200, 225, 250, 315, 355, 400, 450 and 500mm / 2, 2 1/2, 3, 4, 5, 6, 8, 10, 12, 14, 16, 18 & 20",
thickness SDR11 (PN16)

Heating saddles and hole saws must be ordered for each main / outlet diameter.

Complete with integrated hole-saw for completion of procedure.

Hydraulically removed heating plate with PTFE coated radius attachments.

Hydraulic loading system for main pipe.

Count-down timer for heating and cooling times (to be set by operator).

Control panel with electro-hydraulic controls.

400 volt 3 phase 50 Hz (22.1kw 35 A). Optional 60 Hz US voltage also available.

Cylinder area: 12.56cm².

Max. Working Pressure: 63 bar.

Note: When producing saddle fusion tees, outlet diameter should be no greater than 50% of main pipe diameter.

Video: http://www.youtube.com/watch?v=dOta_oucBJg

Specifications are subject to change without notice

ELECTROFUSION



Support equipment for polyethylene pipe and fittings welding including associated accessories.

- **WELDERS**
- **ACCESSORIES**



ATS180

The ATS180 series welding unit has been designed especially for service pipe installation where portability is important, while still keeping reliability in mind. It has been tailored to the construction industry where downtime and problems cost money. It is built in a strong metal case, has a protective heavy duty carry bag and is fitted with tough rubber cables able to put up with the harshest site conditions. It is designed to weld 40V PE pressure fittings from 16mm to 180mm diameter, fully complies with the ISO International Standard for welding equipment, and has automatic bar code operation. It has full data logging capabilities and the data can be downloaded by USB memory drive, and is manufactured in the United Kingdom. The 447 terminals eliminate the need for adaptors due to it being a dual size terminal (both 4.0mm and 4.7mm), and the CCD scanner ensures and easy read of bar codes.

TECHNICAL SPECIFICATIONS

Operating Modes - Manual, Barcode

Controlled Welding Voltage - 39.5V AC (8 to 48V AC)

Welding Current - 1 to 50A

Duty Cycle at 50 amps (in a 3 hour welding period) - 33% (200 sec on / 400 sec off)

Welding Time - 1 to 1000 seconds

Supply Voltage - 110V AC (40 to 60 Hz) / 230V AC 40 to 60 Hz

Supply Current - 1 to 25A (110) / 1 to 12A (230)

Supply Power - 2800 VA (peak)

Weight - 10kg

Size - 30 x 20 x 26 cm

Operating Temperature - -15C to +50C

Programmable Maintenance

Waterproof & Dustproof to IP65

Backlit Four Line Display

Multi-lingual Intuitive Menu

Configurable Operation

Ohms, Volts, Amps Meters Built In

Fusion Time And Energy Displayed

Manual Entry of Fusion Time

Bar Code Entry of Fusion Time

Temperature Compensation

CCD scanner

Data Log Memory (2048 Welds)

Data Download on USB

Software Upgrade by USB

Data Download PC Software

Read Traceability Bar Codes

Operator Welding Pass

Wireless Email and SMS Text - Optional

GPS Location Logging - Optional

Control Point Ready

447 terminals eliminates need to pin adaptors

Specifications are subject to change without notice. Please confirm at time of order confirmation.



ATS250

ATS250 is a fully featured, versatile and easily operated electrofusion welding unit, ideally designed to join PE pressure electrofusion fittings from 16mm to 400mm welding at a constant voltage between 8 volts and 48 volts. European designed and manufactured with portability in mind, it has been constructed in a small lightweight metal case, making it easy to carry and use. Able to weld fittings in both manual and bar code mode, ATS250 has a data log memory of more than 2000 welds which can be downloaded using USB memory. The 447 terminals eliminate the need for adaptors due to it being a dual size terminal (both 4.0mm and 4.7mm), and the CCD scanner ensures an easy read of bar codes.

TECHNICAL SPECIFICATIONS

Capacity - 16mm to 400mm

230 volt operation - (184v to 276v) and 110 volt operation (88v to 132v) operation

40 volt welding (8v-48v)

Waterproof and dustproof to IP65

Backlit four line display

Multi-lingual intuitive menu system

Ohms, Volts, Amps meters built in

Operation configurable by supervisor

Programmable maintenance intervals

Fusion time and energy displayed

Manual entry of fusion time

Bar code entry of fusion time

Ambient temperature compensation

CCD scanner

Data logging memory (2048 welds)

Data download on USB

Software upgrade on USB

Data download PC software

Read and log traceability bar codes

Operator welding pass lock-out

Optional mobile email and SMS text & GPS location coordinate logging at additional cost

Sturdy transportation box

Gross weight - 25kg

Gross dimensions - 30 x 32 x 50cm

Nett weight - 20kg

Nett dimensions - 22 x 26 x 45 cm

Requires minimum 230V 4.5kVa generator - provide full machine details to generator supplier before purchase

447 terminals eliminates need to pin adaptors



LP315

The LP315 is a universal, fully automatic electrofusion welding unit designed to join PE low pressure fittings in the range of 32mm to 315mm. This 230 volt supply unit has been approved for use by Geberit, Wavin and Polypipe. It has been designed with portability in mind and has been constructed in a small lightweight plastic case making it easy to carry and use.



TECHNICAL SPECIFICATIONS

Capacity 32 to 315mm

Welding time 80 to 420 seconds

Supply voltage 230V (40-60Hz)

Supply current 1-14A (230V)

Supply power 3300 W

Weight 4 kg

Size 20 x 10 x 6 cm

Operating temperature 15C to +50C

Environmental protection IP65

Supply cable 5m

Welding cable 3m



ACT3

This automatic electrofusion welding unit is designed to join PE and PP pressure fittings from 16mm to 630mm that weld at a constant voltage between 8 volts and 48 volts. It has been designed for the rental market where its rugged design reduces downtime and saves money, and can weld fittings in manual mode, Fusamatic mode and bar code automatic mode and has a data log memory of more than 2000 welds that can be downloaded using USB memory. The 447 terminals eliminate the need for adaptors due to it being a dual size terminal (both 4.0mm and 4.7mm), and the CCD scanner ensures and easy read of bar codes.

Wireless email and SMS text - Optional

GPS location logging - Optional

Mobile phone App compatible

447 terminals eliminates need to pin adaptors

Technical details are subject to change without notice

TECHNICAL SPECIFICATIONS
Approvals UK - GIS ECE1
Operating mode - Manual, Barcode and Fusamatic
Controlled welding voltage - 39.5 V (8 V to 48 V)
Welding current - 1 to 65A (100A peak)
Welding time - 1 to 3600 seconds
Supply voltage - 110V or 230V (40-60Hz)
Supply current - 1-28A (110V) 1-14A (230V)
Supply power - 3500 W
Weight - 28 kg
Size - 38 x 38 x 40 cm
Operating temperature - -15C to +50C
Programmable Maintenance
Waterproof & Dustproof to IP65
Backlit four line display
Alphanumeric keypad
Multi-lingual intuitive menu
Configurable operation
Ohms, Volts, Amps meters built in
Fusion time and energy displayed
Manual entry of fusion time
Bar code entry of fusion time
Temperature compensation
CCD scanner
Data log memory (2048 welds)
Data download to USB memory
Software upgrade from USB memory
Data download PC software
Read traceability codes
Operator welding pass



ATS High Power

The High Power electrofusion welding unit is designed to join PE and PP pressure fittings from 16mm to 1200mm that weld at a constant voltage between 8 volts and 48 volts. It has been designed with reliability in mind and has been constructed with heavy duty electronics with forced air cooling to allow multiple fittings to be welded in quick succession. It can weld fittings in manual mode and bar code mode, and has a data log memory of more than 2000 welds that can be downloaded using USB memory. The 47 terminals eliminate the need for adaptors due to it being a dual size terminal (both 4.0mm and 4.7mm), and the CCD scanner ensures an easy read of bar codes.



TECHNICAL SPECIFICATIONS

Please take note of acceptable voltages in comparison to the fittings being welded

Approval - ISO 12176-2

Operating modes - Manual, Bar code

Controlled welding voltage - 39.5 V (8 V to 48 V)

Welding current - 1 to 120A

Welding time - 1 to 3600 seconds

Supply voltage - 110V or 230V (40-60Hz)

Supply current - 1-63A (110V) 1-32A (230V)

Supply power - 7400 W

Weight - 42 kg

Size - 50 x 43 x 24 cm

Operating temperature - 15C to +50C

Programmable maintenance

Waterproof / Dustproof to IP65

Backlit four line display

Alphanumeric keypad

Multi-lingual intuitive menu

Configurable operation

Ohms, Volts, Amps meters built in

Fusion time and energy displayed

Manual entry of fusion time

Bar code entry of fusion time

Temperature compensation

CCD scanner

Data log memory (2048 welds)

Data download to USB memory

Software upgrade from USB memory

Data download PC software

Read traceability codes

Operator welding pass

Wireless email and SMS text - Optional

GPS location logging - Optional

Mobile phone App compatible

447 terminals eliminates need to pin adaptors

Technical details are subject to change without notice



ATS4000

The ATS4000 welding unit has been designed specifically to weld large diameter fittings, those above 630mm. These fittings have long weld times and high welding currents, so the unit has heavy-duty electronics, easily capable of these demanding conditions. The unit is built in a strong metal case with forced-air cooling to allow multiple fittings to be welded in quick succession. The unit has full data logging capabilities and can weld in manual or automatic bar code operation. It has a unique “fast weld” mode, allowing bifilar fittings to be welded concurrently, halving the installation time. This is a high-power electrofusion welding unit designed to join PE Storm Water pipes from 500mm to 4000mm that are manufactured by Krah and Polypipe Ridgistorm-XL. It has been designed with reliability in mind and has been constructed with heavy duty electronics with forced air cooling to allow multiple pipes to be welded in quick succession. For larger diameter pipes, two, three or four machines can be used simultaneously without causing interference. It can weld in manual mode and bar code mode, and has a data log memory of more than 2000 welds that can be downloaded using USB memory.

TECHNICAL SPECIFICATIONS

- Approvals - ISO 12176-2
- Operating Modes - Manual, Bar code
- Controlled Welding Voltage - 39.5 V (8 V to 48 V)
- Welding Current - 1 to 120 A
- Supply voltage - 110V or 230V (40-60Hz)
- Supply current - 1-63A (110V) 1-32A (230V)
- Supply power - 7400 W
- Weight - 42 kg
- Size - 50 x 43 x 24 cm
- Operating temperature - 15C to +50C
- Programmable maintenance

Waterproof / Dustproof to IP65

Backlit four line display

Alphanumeric keypad

Multi-lingual intuitive menu

Configurable operation

Ohms, Volts, Amps meters built in

Fusion time and energy displayed

Manual entry of fusion time option

Bar code entry of fusion time

Bar code pen - optional

Bar code scanner

Temperature compensation

Data log memory (2048 welds)

Data download to USB memory

Software upgrade from USB memory

Data download PC software

Read traceability codes

Operator welding pass

Wireless Email and SMS Text - optional

GPS Location Logging - optional

Mobile phone App compatible

Technical details are subject to change without notice



PowerScape1200

PowerScape1200 is a specifically created machine for scraping large diameter HDPE pipes according to the requirements for electrofusion fittings, and helps you to save time and effort on the job-site. It is clamped onto the pipe wall and moves automatically around the pipe's circumference. Pipe ovality does not affect the depth of cut. It is further equipped with a connection for industrial vacuum cleaners. The flexible construction enables a scraping length of up to 350 mm, which is ideal for electrofusion fittings d 355 - d 1200 mm.

TECHNICAL SPECIFICATIONS

Scraping width - 175 / 350mm

Scraping depth - 0.2 (red) / 0.4 (yellow) / 0.6mm (blue)

Scraping speed - 0.8m/min

Weight - 16kg

Power scraping motor - 1600W

Power driving motor - 150W

Input power - 230V /



PolyScraper40 & 62

Robust and easy to use hand tool for manually scraping PE pipe prior to electrofusion.
Manufactured with a plastic handle and hardened steel blade.
Available with a 40mm/1.5" or 62mm/2.5" blade width.

TECHNICAL SPECIFICATIONS

Blade width - 40mm/1.5" or 62mm/2.5"

Operating type - Manual

Approvals - UK: GIS/PL2-5

Size - 17 x 6 x 2 cm

Tool materials - Steel, Plastic

Tool finish - Black plate

VeeClamp250



These tools have been designed to restrain and align pipes before and during the Electrofusion process. They work with pipes between 55mm and 250mm in diameter, those commonly used for mains installation. The pipe sits into a vee shape allowing all sizes of pipe to be held, including non-standard sizes. Reducers can be clamped by using a special reducer plate. Due to the wide vee cradle and the double strap holding, these tools are specifically good at aligning coiled pipes. The three way tool uses a special connector to allow elbows and tees to be held. These tools are completely adjustable making them versatile for every installation.

TECHNICAL SPECIFICATIONS

Operating range - 55mm to 250mm

Operating type - Straight

Size - 100 x 34 x 23 cm

Weight - 15.6 kg

Tool materials - Steel, Nylon

Tool finish - Gold zinc plate

VeeClamp500



These tools have been designed to restrain and align pipes before and during the Electrofusion process. They work with pipes between 55mm and 500mm in diameter, those commonly used for mains installation. The pipe sits into a vee shape allowing all sizes of pipe to be held, including non-standard sizes. Reducers can be clamped by using a special reducer plate. Due to the wide vee cradle and the double strap holding, these tools are specifically good at aligning coiled pipes. The three way tool uses a special connector to allow elbows and tees to be held. These tools are completely adjustable making them versatile for every installation.

TECHNICAL SPECIFICATIONS

Operating range - 55mm to 250mm

Operating type - Straight

Size - 110 x 51 x 28 cm

Weight - 24kg

Tool materials - Steel, Nylon

Tool finish - Gold zinc plate



MultiClamp180

These tools have been designed to restrain, align and re-round pipes before and during the Electrofusion process. They work with 63, 90, 125 and 180mm OD pipes, and can be supplied with 75, 110 & 160mm inserts on request. The holding rings rotate to preset positions of 45 degrees and 90 degrees to allow elbows to be held. Liner shells clip in and out of the holding rings to allow different diameter pipes and reducers to be held and re-rounded.

TECHNICAL SPECIFICATIONS

Operating range - 55mm to 180mm

Operating type - Straight, Elbow

Size - 70 x 27 x 36 cm

Weight - 10.2 kg

Tool materials - Steel, Aluminium, Plastic

Tool finish - Bright zinc plate, Anodised



MultiClamp180 T

They work with pipes between 55mm and 180mm in diameter, those commonly used for mains installation. The holding rings rotate to preset positions of 45 degrees and 90 degrees to allow elbows to be held. Liner shells clip in and out of the holding rings to allow different diameter pipes and reducers to be held and rerounded. The three way tool has an additional leg that allows tees to be held. These tools are completely adjustable making them versatile for every installation.

TECHNICAL SPECIFICATIONS

Operating range - 55mm to 180mm

Operating type - Straight, Elbow

Size - 100 x 27 x 70 cm

Weight - 16.5 kg

Tool materials - Steel, Aluminium, Plastic

Tool finish - Bright zinc plate, Anodised



VariClamp Universal

These tools have been designed to restrain and align pipes before and during the Electrofusion process. They work with pipes between 16mm and 63mm in diameter and are designed to work specifically on service connection pipe. Different sizes can be selected on each arm to allow reducers to be clamped. The backbone of the 'Universal' and 'Variable' clamp can rotate to allow 45 degree and 90 degree elbows to be clamped. The 'Variable' tool has arms that slide on the backbone to allow different width fittings to be held. This is especially useful when clamping elbows directly onto a tapping saddle outlet.

TECHNICAL SPECIFICATIONS

Range - 16mm to 63mm

Type - Straight, Elbow

Size - 23 x 15 x 18 cm

Weight - 1.3kg

Tool materials - Steel, Aluminium, Plastic

Tool finish - Bright zinc plate, Anodised



SaddleClamp500

These tools have been designed to hold saddles onto pipe at the correct pressure, before and during the Electrofusion process. They work with tapping saddles, branch saddles and purge saddles. An indicator button in the middle of the handle shows when the tool is loaded to the correct pressure. With the 'Pillar' style clamps, the pipe holding foot will rotate to allow the tools to be used in a narrow trench. Saddles with stacks of 63mm, 90mm and 125mm can be held by using a special adaptor foot. The tools come in two types, a rigid Pillar type and a more versatile strap holding type.

TECHNICAL SPECIFICATIONS

Operating range - Pipe up to 500mm

Operating type - Top loading saddles

Size - 23 x 13 x 13 cm

Weight - 1.2 kg

Tool materials - Steel, Aluminium, Plastic, Nylon

Tool finish - Bright zinc plate, Anodised

GENERAL MACHINES & ACCESSORIES

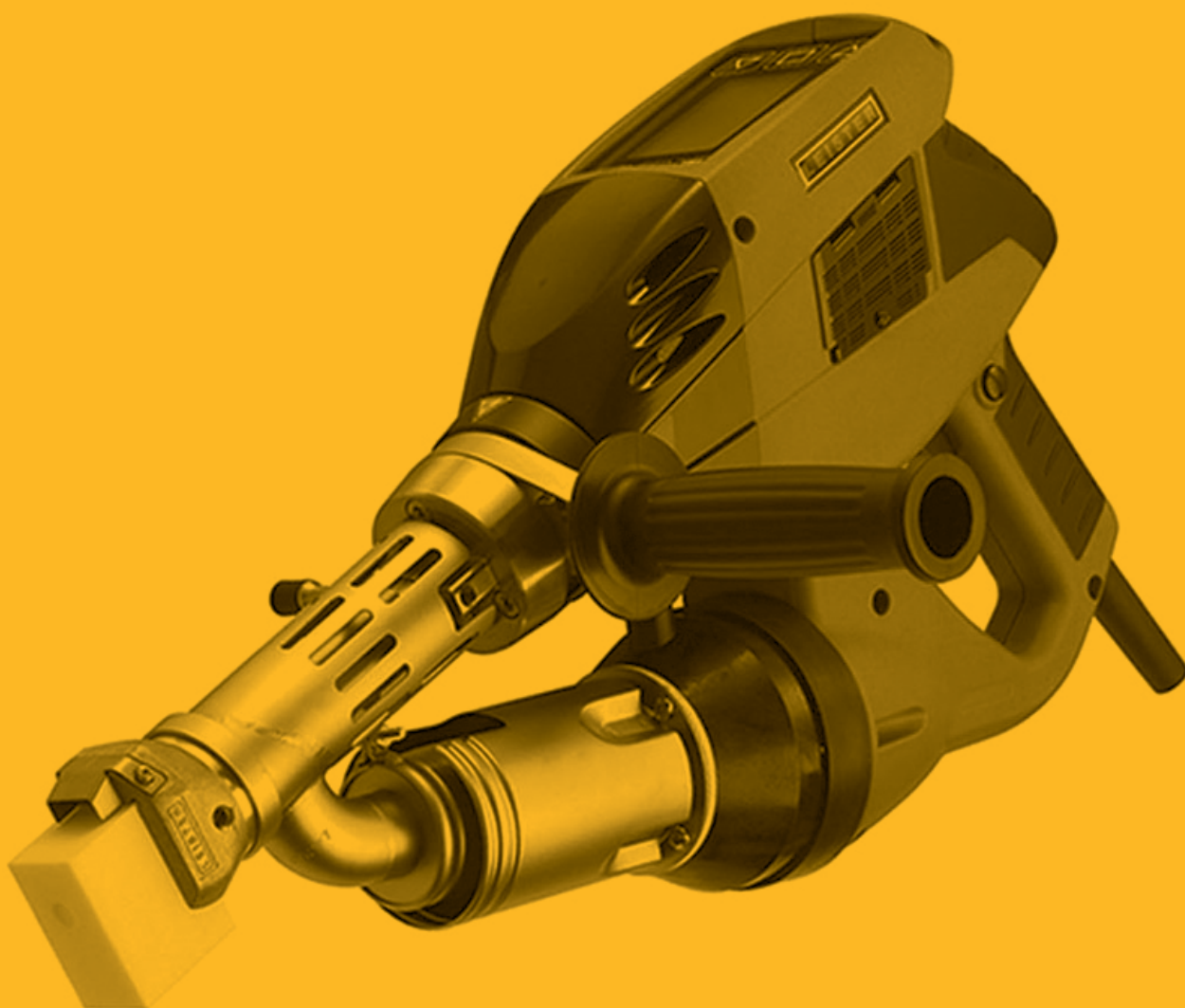

Support equipment for polyethylene pipe and fittings fusion including extrusion welding, sheet welding, data logging and accessories.

- **EXTRUSION WELDING**
- **SHEET WELDING**
- **DATA LOGGING**
- **ACCESSORIES**



Weldplast S2

The WELDPLAST S2 is a compact, ergonomically designed workhorse. The handy size extruder puts out two kilograms per hour and can even weld TPO materials without difficulty.

- Maintenance-free blower
- Perfect weld seam quality
- Multifunctional display
- Ergonomic and handy
- Successfully operated worldwide

TECHNICAL SPECIFICATIONS

Voltage - 230V

Power - 3000W

Welding rod - 3-4mm

Output PE 3mm - 0.6-1.3 kg/h, 4mm - 1.0-2.3 kg/h

Output PP 3mm - 0.5-1.2 kg/h, 4mm - 1.0-2.3 kg/h

Packed size (L x W x H) - 70 x 45 x 19cm

Packed weight - 8kg



Fusion 2

At 450 mm, it is the shortest in its performance class, and as a result of its extremely compact design and rotatable handle, the Fusion 2 is specially suited for tight spaces.

- Very compact and easy to handle with a maximum output rate of 1.8 kg/h
- Robust design (suitable for construction site use)
- Stepless adjustment of preheating temperature and output rate
- Output regulation during welding possible
- Motor starting protection protects the device against cold-starts
- 360° rotatable welding shoe, 180° rotatable handle
- Twist-free rod feed

TECHNICAL SPECIFICATIONS

Voltage - 230V

Power - 2800W

Welding rod - 4 mm

Output PE 4mm - 1.3-1.8 kg/h

Output PP 4mm - 1.3-1.8 kg/h

Packed size (L x W x H) - 70 x 20 x 45cm

Packed weight - 7.5kg



Fusion 3

With its long and narrow shape, the Fusion 3 enables comfortable work, even on the floor.

- Two versions available: 3-4mm or 4-5mm
- High welding performance
- Compact and handy
- Motor start-up protection prevents cold start
- Dual-sided twist-free wire intake
- 360 degrees rotatable welding shoe

TECHNICAL SPECIFICATIONS

Voltage - 230V

Power - 3500W

Welding rod - 3-4mm or 4-5mm. Must specify which version is required upon order

3-4mm version:

Output PE 3mm - 2.0–2.5 kg/h, 4mm - 2.7–3.6 kg/h

Output PP 3mm - 1.8–2.3 kg/h, 4mm - 2.5–3.4 kg/h

4-5mm version:

Output PE 4mm - 2.1–2.6 kg/h, 5mm - 2.7–3.6 kg/h

Output PP 4mm - 1.8–2.4 kg/h, 5mm - 2.5–3.4 kg/h

Size (L x W x H) - 67 x 9 x 18cm

Weight - 7.2kg



Fusion 3C

The somewhat shorter Fusion 3C provides an astounding output volume of up to 3.6 kilograms per hour.

- Two versions available: 3-4mm or 4-5mm
- High welding performance
- Compact and handy
- Motor start-up protection prevents cold start
- Dual-sided twist-free wire intake
- 360° rotatable welding shoe

TECHNICAL SPECIFICATIONS

Voltage - 230V

Power - 3500W

Welding rod - 3-4mm or 4-5mm. Must specify which version is required upon order

Output PE 3mm - 2.0–2.5 kg/h, 4mm - 2.7–3.6 kg/h

Output PP 3mm - 1.8–2.3 kg/h, 4mm - 2.5–3.4 kg/h

Output PE 4mm - 2.1–2.6 kg/h, 5mm - 2.7–3.6 kg/h

Output PP 4mm - 1.8–2.4 kg/h, 5mm - 2.5–3.4 kg/h

Size (L x W x H) - 58.8 x 9.8 x 22.5cm

Weight - 6.9kg

Must specify if the 3-4mm or 4-5mm version is required upon order



Made in Switzerland

ASTRO

The ASTRO is used all over the world. Welding up to five meters per minute, their robust design and easy handling make it the perfect workhorse.

- Simple operation
- Digital display
- One-handle operation
- Pendulum head
- Pressure sensor

TECHNICAL SPECIFICATIONS

Voltage - 230V

Frequency - 50/60Hz

Power Consumption - 1.8Kw

Temperature - 20-420C

Speed - 0.8-5.0 m/min

Welding pressure - 100-1500N

Welding seam width - 2 x 15mm, with test channel

Material thickness - 1.5-3.0mm

Size (L x W x H) - 430 x 270 x 310mm

Weight - 23kg



Made in Switzerland

COMET

This compact, heavy-duty welding machine is in use all over the world, and for good reason; the small and easy to use powerhouse is specially designed for the demands of landfill sites, mines and tunnels.

- Lightweight and compact
- Digital display of temperature and velocity
- Closed loop control of temperature and drive
- Easy to use and user-friendly

TECHNICAL SPECIFICATIONS

Voltage - 230V

Frequency - 50/60Hz

Power Consumption - 1.850/1.5/1.2Kw

Temperature - 20-420C

Max. overlap - 125mm

Speed - 0.8-3.2 m/min

Welding pressure - 100-1000N

Welding seam width - 2 x 15, with test channel

Material thickness - 0.5-3.0mm

Size (L x W x H) - 295 x 250 x 245mm

Weight - 7.5kg



SPG 2.0 Data Logger

The SPG 2.0 data logger is made for easy and safe welding process control, and report generation pursuant to ISO 12176 standard.

The control software ships with configurations for many third-party systems already installed, meaning the logger constitutes as an upgrade for manually operated welding machines to achieve ISO-compliant recording, error handling, and welding process control.

At every step in the welding process, the SPG 2.0 indicates the nominal and the actual values of the welding pressures and times, to walk the welder operating the hydraulic unit easily and correctly through the process.

The unit thereby achieves the optimum welding process, in line with nationally applicable standards, as affecting both heating element temperatures and welding pressures and times.

TECHNICAL SPECIFICATIONS

Automatic data logging of 10,000 weld reports, output to USB and printing to Excel

Report generation pursuant to ISO 12176 standard

Constitutes as an upgrade for manually operated welding machines to achieve ISO-compliant recording and welding process control

Technical specifications may change without notice



WPD DataMaster

A Data Logger for fast, accurate monitoring and recording of weld values under DVS and POP003 both low and high pressure welding. The Data Logger can be universally used with any Worldpoly butt-welding machine and with all hydraulically operated machines. It is possible to capture all the data needed to evaluate the quality of a welding operation (including plate temperature) and to transfer them to a printer or a PC. Memory holds up to 1000 weld cycles, and provides a good weld / bad weld advice for each weld.

TECHNICAL SPECIFICATIONS

Programmed for DVS & ISO welding standards

Input Voltage 100 volts - 260 volts, Input frequency 40-80Hz

Box Protection IP54

Report capacity: 1000 welding operations

Multilingual menus and reports

Pressure sensor 100 bars or 250 bars, as selected

Convenient carry case

Technical specifications may change without notice



PolyRoller1000

Australian made adjustable pipe roller stands with a capacity of 50 to 1000mm OD PE pipe.

The height adjustment is based on a chain fixed to the bottom of each arm, and height can be adjusted from 200mm to 1000mm off the ground.

SWL is 1000kg per stand.

TECHNICAL SPECIFICATIONS

Australian made

Safe working load 1000kg per stand

Capacity 50 to 1000mm

Weight 25kg per stand, including chain

Specifications are subject to change without notice. Please confirm at time of order.



PolySling 500, 1000 & 1200

Australian Made 5 roller sling.

Available in 3 sizes:

- 100 - 500mm
- 315 - 1000mm
- 50 - 1200mm

All have a SWL of 3000kg.

The sling is supplied tested and tagged with a safe working load.

TECHNICAL SPECIFICATIONS

Australian made

Available in 500mm, 1000mm and 1200mm sizes

Wire capacity of 3000kg

Load tested & certified

Specifications are subject to change without notice. Please confirm at time of order.



SqueezeOff32, 63, 90 & 125

These tools have been designed to restrict the flow of gas or water in a plastic pipe, while a repair is carried out. They squeeze the pipe down to a set amount, as defined in the UK National Grid specification GIS/PL2-7.

To ensure the pipe is not damaged during operation, the tool is fitted with rotatable profiles that set the correct gap.

The tools are manufactured from steel to ensure reliable operation under harsh operating conditions.

The pipe is squeezed shut by two parallel bars, the top bar being moved by a manual operation tee handle, the bottom bar being removable to allow easier access for the pipe.

TECHNICAL SPECIFICATIONS

SqueezeOff32 operating range: 16mm to 32mm

SqueezeOff63 operating range: 20mm to 63mm

SqueezeOff90 operating range: 55mm to 90mm

SqueezeOff125 operating range: 63mm to 125mm

Operating type: Manual

Approvals UK: GIS/PL2-7

Size: From 28 x 29 x 6cm (SqueezeOff32) to 35 x 41 x 7 cm (SqueezeOff125)

Weight: From 4.5kg(SqueezeOff32) to 9.5kg (SqueezeOff125)



ButtWipe

ButtWipes assist with the necessary preparation of equipment surfaces and pipe ends, in order to ensure freedom from contaminants as is necessary for a successful welding process in both butt & electrofusion welding.

1 tub of ButtWipes contains 75 wipes with a >92% Isopropyl Alcohol content.

For use on pipes only, not humans.



External Debeader DE125, 400, 500 & 900

These tools have been designed to remove the external bead from a butt-fusion welded joint. The tool knocks on to the pipe bead, then alignment blocks slide against the pipe surface to guide it around the pipe. They have a blade that cuts under the bead, but does not damage the surface of the pipe. A handle helps pull the tool around the pipe, cutting the bead away. The tools are available in four sizes: 125mm, 400mm, 500mm and 900mm.

These tools are fully approved to the UK National Grid specifications GIS/PL2-5 and have been accepted for use on their gas networks and pipes.

TECHNICAL SPECIFICATIONS

Available in sizes to debead up to 125, 400, 500 & 900mm OD PE or PP pipe

Operating type: Manual

Approvals: UK GIS PL-2.5

Operating Temperature: -40°C to +50°C

Tool materials: Steel

Tool finish: Bright Zinc plate



PipeSecateur75

This tool has been designed to quickly and precisely cut PE or PP pipe before the electrofusion process takes place, and works with pipes from 16mm to 75mm diameter.

TECHNICAL SPECIFICATIONS

Operating range: 16mm to 75mm

Operating type: Secateurs

Size: 47cm x 17cm x 3cm

Weight: 1.7kg



Internal Debeader 90-450mm & 500-630mm

Manual bead removing equipment for internal beads from 590-450mm or 500mm to 630 mm. The internal debeader is used for removing the weld bead in PE and PP plastic pipe after a butt weld has been completed.

To use the unit, the internal debeader must be assembled to the correct diameter and inserted into the pipe. It is then pushed toward the bead until the operator feels a "bump", at which point the handle is turned clockwise 360 degrees, and then removed (along with the bead) from the pipe.

Note that debeading must be completed within the first 1/3 of the weld cooling time.

TECHNICAL SPECIFICATIONS

Options available:

90 - 450mm model

90 to 110mm OD (70 to 105mm ID)

125 to 160mm OD (105 to 145mm ID)

160 to 200mm OD (135 to 190mm ID)

225 to 280mm OD (181 to 266mm ID)

315 to 450mm OD (265 to 420mm ID)

500 - 710mm model

500 to 630 mm OD

630 to 710mm OD

Above 710mm on request

Made in Denmark

Please note technical specifications of Worldpoly machines may change without notice



**AUSTRALIAN
ENGINEERED
FOR A TOUGH
WORLD**

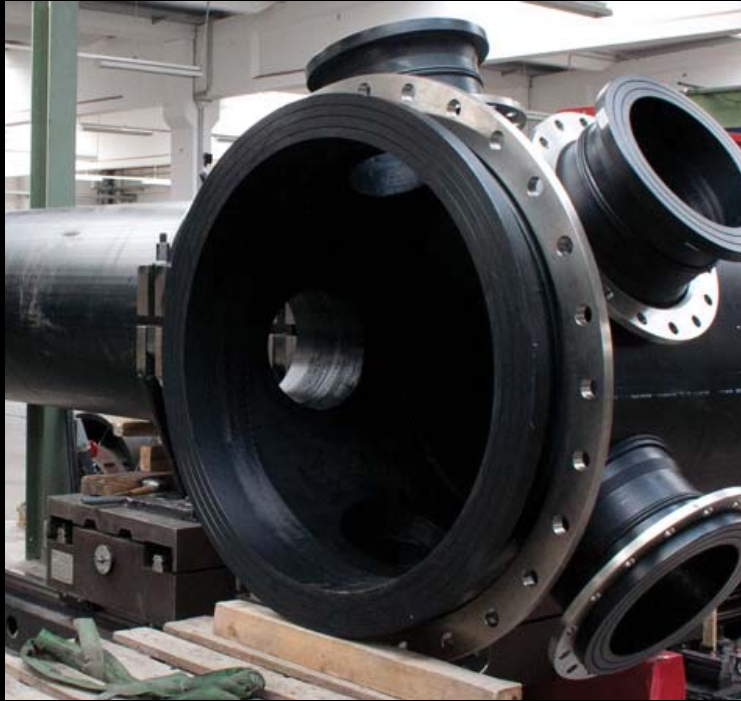

**FROM THE MINES IN
THE DESERTS OF SOUTH
AMERICA, FISH FARMS
IN MALYSIA TO FREEZE
RESISTANT WELDS IN
ANTARCTICA, WORLDPOLY
HAS DONE IT ALL**



WORLDPOLY DEALER REGIONS

To find a dealer most appropriate for you,
match the region colour with the contact details below.

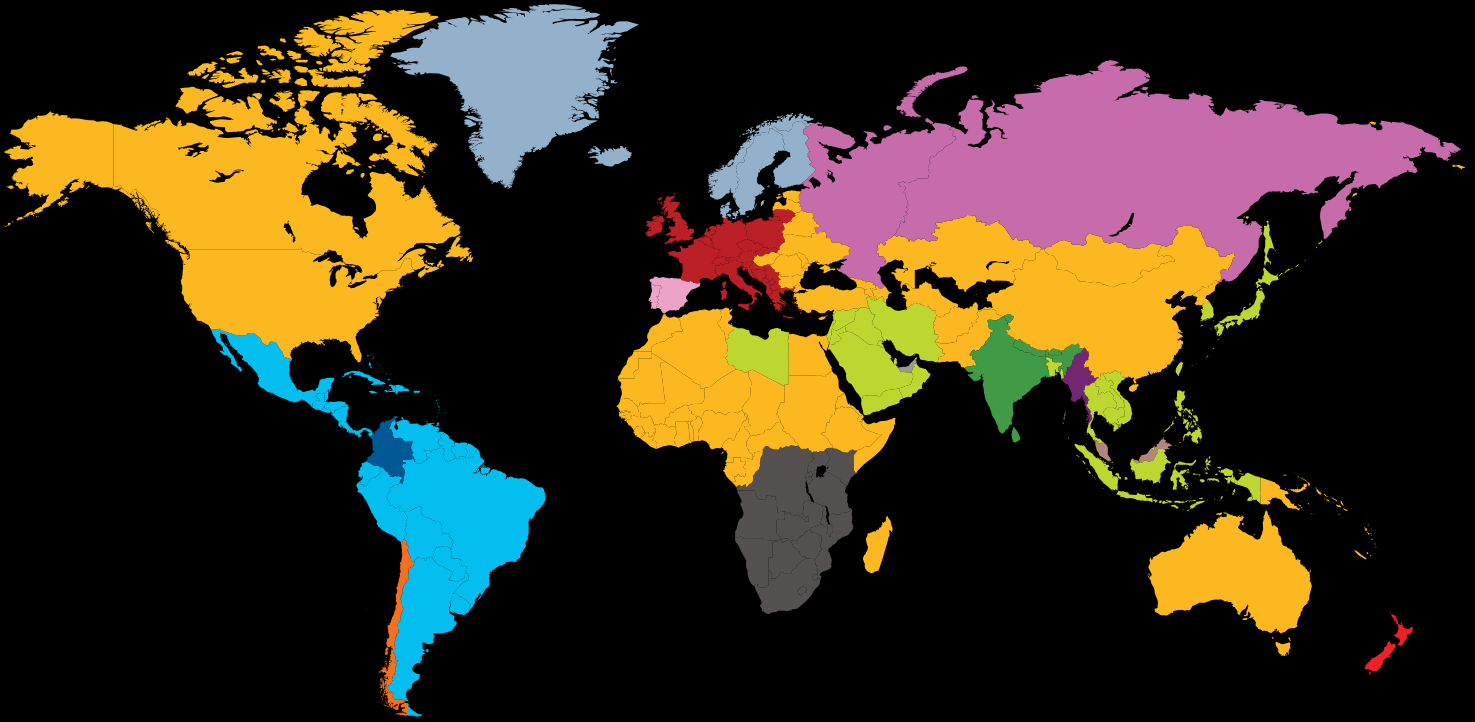

Australia (Head Office)

+61 (0)3 8795 3888
sales@worldpoly.com
www.worldpoly.com
2/5 Commercial Drive,
Lynbrook VIC 3975
Australia



Asia and Middle East

+61 (0)488 774 282
asiame@worldpoly.com
www.worldpoly.com



Chile

+56 2 738 7340
+56 2 738 7341
ventas@termopro.cl
www.termopro.cl



Colombia

+57 4 3528585
info@tecnopipe.com
www.tecnopipe.com



Germany

+49 281 98 414 0
sales@star.de.com
www.star-kunststoffe.de



India

+91 94 2320 2277
india@worldpoly.com
www.worldpoly.com



Latin America

+56 2 738 7340
+56 2 738 7341
ventas@worldpoly.com
www.worldpoly.com



Mexico

+52 (81) 83847363
www.agrufimex.com



New Zealand

+64 4 238 4452
+64 4 238 6170
sales@upg.net.nz
www.upg.net.nz



Panama

+507 394 5440
info@sigsapanama.com
www.sigsapanama.com



Philippines

+63 2 841 0166
sales@infratex.com
www.infratex.com



Scandinavia

+47 71173466
pmksalg@pmktec.info
www.pmktec.info



Spain and Portugal

+34 91 692 71 60
info@querotools.com
www.queru-sa.es



Sub-Saharan Africa

+27 82 309 6034
shawn@polyafrica.co.za
www.stp-sa.com



United Arab Emirates

+97529893921
+971508769083
sales@fptme.com
www.fptme.com

